

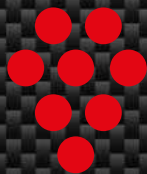

RIEDEL SUPERLEGGERO



RETAIL
PICTURE BOOK 2023

EFFECTIVE: MAY 1ST, 2023

IF YOUR WINE COULD CHOOSE A GLASS, IT WOULD BE RIEDEL.



NEW ITEMS 2023	
RIEDEL LAUDON	6
RIEDEL SUPERLEGGERO	8
RIEDEL DRINK SPECIFIC GLASSWARE	10
RIEDEL MIXING SETS	11
DECANTERS HANDMADE	12
DECANTER MACHINE-MADE	13
GLASS COLLECTION	
SOMMELIERS	14
SOMMELIERS BLACK TIE	24
BLACK SERIES COLLECTOR'S EDITION	28
RIEDEL HIGH PERFORMANCE	32
RIEDEL FATTO A MANO PERFORMANCE	36
RIEDEL FATTO A MANO	40
PREMIUM MACHINE-MADE	
RIEDEL LAUDON	64
RIEDEL SUPERLEGGERO	70
RIEDEL WINEWINGS	74
RIEDEL VELOCE	80
RIEDEL VERITAS	86
RIEDEL PERFORMANCE	94
VINUM	100
MACHINE-MADE	
EXTREME	114
HEART TO HEART	122
RIEDEL DRINK SPECIFIC GLASSWARE	126
RIEDEL WINE FRIENDLY	132
TUMBLER COLLECTION	136
OUVERTURE	140
SL RIEDEL STEMLESS WINGS	144
O WINE TUMBLER	148
HAPPY O	154
SWIRL	160
MIXING SETS	162
RIEDEL BAR	170
DECANTERS HANDMADE	174
DECANTERS MACHINE-MADE	196
ACCESSORIES	198
VALUE GIFT PACKS	202
EOS SPECIAL ITEMS	214
ACCANTO	216
VIVANT	222
TRADEMARK	228
ALL ABOUT RIEDEL	230
CUSTOM MADE	234
INSTRUCTIONS	236
LOGO AND POUR AID	238
GO GREEN - SUSTAINABILITY	240
GENERAL TERMS AND CONDITIONS	241

Shipments are subject to our General Terms and Conditions and respective Payment and Delivery Terms. We do not accept other delivery Terms and Conditions and respective Payment and Delivery Terms. Our General Terms and Conditions of Contract and respective Payment and Delivery Terms may be viewed by means of display and notice board in our business offices and can be submitted on request. You are accepting these General Terms and Conditions and respective Payment and Delivery Terms when the contract is concluded.

We regret any errors in our specifications for sizes, colours, volumes or prices. However, claims resulting from such errors cannot be accepted. The packaging shown are example packaging.



FACTORY KUFSTEIN

Production: **fine crystal, handmade**
Employees: 140
Melting Capacity: 1.8 t per day
Production Capacity: 250,000 pieces per year



FACTORY WEIDEN

Production: **fine crystal, premium machine-made, fully automated production**
Employees: 250
Melting Capacity: 50 t per day
Production Capacity: 26 million pieces per year



FACTORY AMBERG

Production: **fine crystal, machine-made, fully automated production**
Employees: 150
Melting Capacity: 28 t per day
Production Capacity: 23 million pieces per year



CENTAL WAREHOUSE WEIDEN

Employees: 75







Tumbler
Gold



Tumbler
Silver

ITEM	Item no.: 1515/02S3AU fine crystal premium machine-made	Item no.: 1515/02S3S fine crystal premium machine-made
	Height/glass: 102 mm	Height/glass: 102 mm
	Capacity/glass: 295 ccm	Capacity/glass: 295 ccm
	Design: 2022	Design: 2022
PACKAGING TYPE AND QUANTITY	Pieces/Bill unit: 1 Bill units/MP: 4	Pieces/Bill unit: 1 Bill units/MP: 4
BILL UNIT DIMENSIONS	Length: 86 mm Width: 86 mm Height: 110 mm Weight: 445 gr	Length: 86 mm Width: 86 mm Height: 110 mm Weight: 445 gr
MASTERPACK DIMENSIONS	Length: 184 mm Width: 184 mm Height: 122 mm Weight: 1854 gr	Length: 184 mm Width: 184 mm Height: 122 mm Weight: 1854 gr
EURO PALLET	Bill units/pallet: 864 Bill units/layer: 96 Layers/pallet: 9	Bill units/pallet: 864 Bill units/layer: 96 Layers/pallet: 9
CONTAINER PALLET HIGH CUBE	Bill units/pallet: 1200 Bill units/layer: 120 Layers/pallet: 10	Bill units/pallet: 1200 Bill units/layer: 120 Layers/pallet: 10
EAN BILL UNIT	 9 006206 325184	 9 006206 325177





RIEDEL LAUDON TUMBLER GOLD 1515/02S3AU AND SILVER 1515/02S3S



Bordeaux Grand Cru



Burgundy Grand Cru



Hermitage / Syrah



Champagne Wine Glass

ITEM	Item no.: 6425/00 fine crystal premium machine-made	Item no.: 6425/16 fine crystal premium machine-made	Item no.: 6425/41 fine crystal premium machine-made	Item no.: 6425/28 fine crystal premium machine-made
	Height/glass: 282 mm	Height/glass: 276 mm	Height/glass: 267 mm	Height/glass: 260 mm
	Capacity/glass: 953 ccm	Capacity/glass: 1022 ccm	Capacity/glass: 668 ccm	Capacity/glass: 464 ccm
	Design: 2023	Design: 2023	Design: 2023	Design: 2023
PACKAGING	Pieces/Bill unit: 1	Pieces/Bill unit: 1	Pieces/Bill unit: 1	Pieces/Bill unit: 1
TYPE AND QUANTITY	Bill units/MP: 4	Bill units/MP: 4	Bill units/MP: 4	Bill units/MP: 4
BILL UNIT	Length: 329 mm	Length: 329 mm	Length: 329 mm	Length: 329 mm
DIMENSIONS	Width: 138 mm	Width: 138 mm	Width: 138 mm	Width: 138 mm
	Height: 132 mm	Height: 132 mm	Height: 132 mm	Height: 132 mm
	Weight: 336 gr	Weight: 339 gr	Weight: 317 gr	Weight: 296 gr
MASTERPACK	Length: 282 mm	Length: 282 mm	Length: 282 mm	Length: 282 mm
DIMENSIONS	Width: 272 mm	Width: 272 mm	Width: 272 mm	Width: 272 mm
	Height: 340 mm	Height: 340 mm	Height: 340 mm	Height: 340 mm
	Weight: 1584 gr	Weight: 1596 gr	Weight: 1508 gr	Weight: 1424 gr
EURO PALLET	Bill units/pallet: 160	Bill units/pallet: 160	Bill units/pallet: 160	Bill units/pallet: 160
	Bill units/layer: 32	Bill units/layer: 32	Bill units/layer: 32	Bill units/layer: 32
	Layers/pallet: 5	Layers/pallet: 5	Layers/pallet: 5	Layers/pallet: 5
CONTAINER PALLET	Bill units/pallet: 288	Bill units/pallet: 288	Bill units/pallet: 288	Bill units/pallet: 288
HIGH CUBE	Bill units/layer: 48	Bill units/layer: 48	Bill units/layer: 48	Bill units/layer: 48
	Layers/pallet: 6	Layers/pallet: 6	Layers/pallet: 6	Layers/pallet: 6
EAN				
BILL UNIT	9 006206 326020	9 006206 326082	9 006206 326075	9 006206 326068





Sauvignon Blanc







Riesling



Chardonnay



Spirits

ITEM	Item no.: 6425/33 fine crystal premium machine-made	Item no.: 6425/15 fine crystal premium machine-made	Item no.: 6425/97 fine crystal premium machine-made	Item no.: 6425/10 fine crystal premium machine-made
	Height/glass: 261 mm	Height/glass: 252 mm	Height/glass: 234 mm	Height/glass: 244 mm
	Capacity/glass: 400 ccm	Capacity/glass: 400 ccm	Capacity/glass: 660 ccm	Capacity/glass: 248 ccm
	Design: 2023	Design: 2023	Design: 2023	Design: 2023
PACKAGING	Pieces/Bill unit: 1	Pieces/Bill unit: 1	Pieces/Bill unit: 1	Pieces/Bill unit: 1
TYPE AND QUANTITY	Bill units/MP: 4	Bill units/MP: 4	Bill units/MP: 4	Bill units/MP: 4
BILL UNIT	Length: 329 mm	Length: 329 mm	Length: 329 mm	Length: 329 mm
DIMENSIONS	Width: 138 mm	Width: 138 mm	Width: 138 mm	Width: 138 mm
	Height: 132 mm	Height: 132 mm	Height: 132 mm	Height: 132 mm
	Weight: 299 gr	Weight: 292 gr	Weight: 308 gr	Weight: 281 gr
MASTERPACK	Length: 282 mm	Length: 282 mm	Length: 282 mm	Length: 282 mm
DIMENSIONS	Width: 272 mm	Width: 272 mm	Width: 272 mm	Width: 272 mm
	Height: 340 mm	Height: 340 mm	Height: 340 mm	Height: 340 mm
	Weight: 1436 gr	Weight: 1408 gr	Weight: 1472 gr	Weight: 1364 gr
EURO PALLET	Bill units/pallet: 160	Bill units/pallet: 160	Bill units/pallet: 160	Bill units/pallet: 160
	Bill units/layer: 32	Bill units/layer: 32	Bill units/layer: 32	Bill units/layer: 32
	Layers/pallet: 5	Layers/pallet: 5	Layers/pallet: 5	Layers/pallet: 5
CONTAINER PALLET	Bill units/pallet: 288	Bill units/pallet: 288	Bill units/pallet: 288	Bill units/pallet: 288
HIGH CUBE	Bill units/layer: 48	Bill units/layer: 48	Bill units/layer: 48	Bill units/layer: 48
	Layers/pallet: 6	Layers/pallet: 6	Layers/pallet: 6	Layers/pallet: 6
EAN				
BILL UNIT	9 006206 326051	9 006206 326013	9 006206 326044	9 006206 326037





Nick & Nora Glass Large



Sour Glass Optic



Coffee Glass

ITEM	Item no.: fine crystal machine-made	6417/08	Item no.: fine crystal machine-made	6417/09	Item no.: fine crystal machine-made	6417/10
	Height/glass:	177 mm	Height/glass:	158 mm	Height/glass:	63 mm
	Capacity/glass:	198 ccm	Capacity/glass:	215 ccm	Capacity/glass:	90 ccm
	Design:	2023	Design:	2023	Design:	2023
PACKAGING	Pieces/Bill unit:	2	Pieces/Bill unit:	2	Pieces/Bill unit:	2
TYPE AND QUANTITY	Bill units/MP:	4	Bill units/MP:	4	Bill units/MP:	4
BILL UNIT	Length:	227 mm	Length:	227 mm	Length:	140 mm
DIMENSIONS	Width:	116 mm	Width:	116 mm	Width:	70 mm
	Height:	224 mm	Height:	224 mm	Height:	82 mm
	Weight:	462 gr	Weight:	472 gr	Weight:	282 gr
MASTERPACK	Length:	475 mm	Length:	475 mm	Length:	148 mm
DIMENSIONS	Width:	232 mm	Width:	232 mm	Width:	148 mm
	Height:	240 mm	Height:	240 mm	Height:	172 mm
	Weight:	2080 gr	Weight:	2120 gr	Weight:	1194 gr
EURO PALLET	Bill units/pallet:	196	Bill units/pallet:	196	Bill units/pallet:	1400
	Bill units/layer:	28	Bill units/layer:	28	Bill units/layer:	140
	Layers/pallet:	7	Layers/pallet:	7	Layers/pallet:	10
CONTAINER PALLET	Bill units/pallet:	360	Bill units/pallet:	360	Bill units/pallet:	1792
HIGH CUBE	Bill units/layer:	40	Bill units/layer:	40	Bill units/layer:	224
	Layers/pallet:	9	Layers/pallet:	9	Layers/pallet:	98
EAN	 9 006206 325832		 9 006206 325894		 9 006206 326099	





Mixing Set Rosé



Mixing Set Cognac

ITEM	Item no.:	5515/55	Item no.:	5515/71
	fine crystal machine-made		fine crystal machine-made	
	Height/glass:	230 mm	Height/glass:	190 mm
	Capacity/glass:	322 ccm	Capacity/glass:	175 ccm
	Design:	2023	Design:	2023
PACKAGING	Pieces/Bill unit:	4	Pieces/Bill unit:	4
TYPE AND QUANTITY	Bill units/MP:	4	Bill units/MP:	2
BILL UNIT	Length:	177 mm	Length:	150 mm
DIMENSIONS	Width:	177 mm	Width:	150 mm
	Height:	241 mm	Height:	200 mm
	Weight:	768 gr	Weight:	572 gr
MASTERPACK	Length:	364 mm	Length:	308 mm
DIMENSIONS	Width:	364 mm	Width:	157 mm
	Height:	254 mm	Height:	214 mm
	Weight:	3368 gr	Weight:	1256 gr
EURO PALLET	Bill units/pallet:	168	Bill units/pallet:	272
	Bill units/layer:	24	Bill units/layer:	34
	Layers/pallet:	7	Layers/pallet:	8
CONTAINER PALLET	Bill units/pallet:	216	Bill units/pallet:	420
HIGH CUBE	Bill units/layer:	24	Bill units/layer:	42
	Layers/pallet:	9	Layers/pallet:	10
EAN BILL UNIT	 9 006206 325771		 9 006206 325764	





RIEDEL Amadeo Moonlight Decanter RIEDEL Amadeo Sunshine Decanter RIEDEL Chinese Zodiac Rabbit Decanter Red/Yellow RIEDEL Chinese Zodiac Dragon Decanter Red/Yellow

ITEM	Item no.: fine crystal handmade	1756/23-M	Item no.: fine crystal handmade	1756/23-S	Item no.: fine crystal handmade	2009/23S1	Item no.: fine crystal handmade	2009/24S1
	Height/glass:	350 mm	Height/glass:	350 mm	Height/glass:	365 mm	Height/glass:	365 mm
	Capacity/glass:	1500 ccm	Capacity/glass:	1500 ccm	Capacity/glass:	1210 ccm	Capacity/glass:	1210 ccm
	Design:	2023	Design:	2023	Design:	2023	Design:	2024
PACKAGING	Pieces/Bill unit:	1	Pieces/Bill unit:	1	Pieces/Bill unit:	1	Pieces/Bill unit:	1
TYPE AND QUANTITY	Bill units/MP:	1	Bill units/MP:	1	Bill units/MP:	1	Bill units/MP:	1
BILL UNIT	Length:	397 mm	Length:	397 mm	Length:	172 mm	Length:	172 mm
DIMENSIONS	Width:	229 mm	Width:	229 mm	Width:	172 mm	Width:	172 mm
	Height:	129 mm	Height:	129 mm	Height:	476 mm	Height:	476 mm
	Weight:	1012 gr	Weight:	1012 gr	Weight:	990 gr	Weight:	990 gr
MASTERPACK	Length:	397 mm	Length:	397 mm	Length:	177 mm	Length:	177 mm
DIMENSIONS	Width:	234 mm	Width:	234 mm	Width:	177 mm	Width:	177 mm
	Height:	135 mm	Height:	135 mm	Height:	477 mm	Height:	477 mm
	Weight:	1144 gr	Weight:	1144 gr	Weight:	1121 gr	Weight:	1121 gr
EURO PALLET	Bill units/pallet:	91	Bill units/pallet:	91	Bill units/pallet:	90	Bill units/pallet:	90
	Bill units/layer:	7	Bill units/layer:	7	Bill units/layer:	9	Bill units/layer:	9
	Layers/pallet:	13	Layers/pallet:	13	Layers/pallet:	10	Layers/pallet:	10
CONTAINER PALLET	Bill units/pallet:	208	Bill units/pallet:	208	Bill units/pallet:	182	Bill units/pallet:	182
HIGH CUBE	Bill units/layer:	13	Bill units/layer:	13	Bill units/layer:	14	Bill units/layer:	14
	Layers/pallet:	16	Layers/pallet:	16	Layers/pallet:	13	Layers/pallet:	13
EAN								
BILL UNIT	9 006206 325795		9 006206 325788		9 006206 325009		9 006206 325719	



Limited Editions: TG reserves the right to offer glassware marked as "Limited Edition" in a certain amount and for a certain time period and under certain allocation criteria to Customer.

Limited Editions: TG reserves the right to offer glassware marked as "Limited Edition" in a certain amount and for a certain time period and under certain allocation criteria to Customer.

Limited Editions: TG reserves the right to offer glassware marked as "Limited Edition" in a certain amount and for a certain time period and under certain allocation criteria to Customer.

Limited Editions: TG reserves the right to offer glassware marked as "Limited Edition" in a certain amount and for a certain time period and under certain allocation criteria to Customer.

LIMITED EDITION OF 500 PIECES.

LIMITED EDITION OF 500 PIECES.



Mosel Magnum Decanter

ITEM	Item no.: 1419/23 fine crystal machine-made
	Height/glass: 285 mm Capacity/glass: 2087 ccm Design: 2023
PACKAGING	Pieces/Bill unit: 1
TYPE AND QUANTITY	Bill units/MP: 2
BILL UNIT	Length: 140 mm
DIMENSIONS	Width: 140 mm Height: 294 mm Weight: 612 gr
MASTERPACK	Length: 291 mm
DIMENSIONS	Width: 148 mm Height: 310 mm Weight: 1358 gr
EURO PALLET	Bill units/pallet: 240 Bill units/layer: 40 Layers/pallet: 6
CONTAINER PALLET	Bill units/pallet: 392
HIGH CUBE	Bill units/layer: 56 Layers/pallet: 7
EAN BILL UNIT	 9 006206 325818







RIEDEL
50
YEARS

sommeliers
— SINCE 1973 —

HANDMADE

SOMMELIERS (1973)

- RIEDEL'S CLASSIC
- THE FIRST VARIETAL SPECIFIC STEMWARE LINE

The introduction of the SOMMELIERS series in 1973 achieved worldwide recognition. A glass was born that turns a sip into a celebration - a wine's best friend - fine-tuned to match the grape! We invite you to share this fascinating and unique experience. You don't need to be a wine writer, a wine maker or an expert to taste the difference that a RIEDEL glass can make.



Bordeaux Grand Cru



Burgundy Grand Cru



Tinto Reserva



Hermitage

ITEM	Item no.: 4400/00 fine crystal handmade	Item no.: 4400/16 fine crystal handmade	Item no.: 4400/31 fine crystal handmade	Item no.: 4400/30 fine crystal handmade
	Height/glass: 270 mm Capacity/glass: 860 ccm Design: 1959	Height/glass: 248 mm Capacity/glass: 1050 ccm Design: 1958	Height/glass: 248 mm Capacity/glass: 620 ccm Design: 1987	Height/glass: 235 mm Capacity/glass: 590 ccm Design: 1995
PACKAGING TYPE AND QUANTITY	Pieces/Bill unit: 1 Bill units/MP: 4	Pieces/Bill unit: 1 Bill units/MP: 4	Pieces/Bill unit: 1 Bill units/MP: 4	Pieces/Bill unit: 1 Bill units/MP: 4
BILL UNIT DIMENSIONS	Length: 146 mm Width: 133 mm Height: 327 mm Weight: 388 gr	Length: 146 mm Width: 133 mm Height: 327 mm Weight: 398 gr	Length: 146 mm Width: 133 mm Height: 327 mm Weight: 378 gr	Length: 146 mm Width: 133 mm Height: 327 mm Weight: 373 gr
MASTERPACK DIMENSIONS	Length: 304 mm Width: 286 mm Height: 343 mm Weight: 1812 gr	Length: 304 mm Width: 286 mm Height: 343 mm Weight: 1852 gr	Length: 304 mm Width: 286 mm Height: 343 mm Weight: 1772 gr	Length: 304 mm Width: 286 mm Height: 343 mm Weight: 1752 gr
EURO PALLET	Bill units/pallet: 192 Bill units/layer: 32 Layers/pallet: 6	Bill units/pallet: 192 Bill units/layer: 32 Layers/pallet: 6	Bill units/pallet: 192 Bill units/layer: 32 Layers/pallet: 6	Bill units/pallet: 192 Bill units/layer: 32 Layers/pallet: 6
CONTAINER PALLET HIGH CUBE	Bill units/pallet: 288 Bill units/layer: 48 Layers/pallet: 6	Bill units/pallet: 288 Bill units/layer: 48 Layers/pallet: 6	Bill units/pallet: 288 Bill units/layer: 48 Layers/pallet: 6	Bill units/pallet: 288 Bill units/layer: 48 Layers/pallet: 6
EAN BILL UNIT				





Zinfandel







Mature Bordeaux



Vintage Champagne Glass



Champagne Glass

ITEM	Item no.: 4400/15 fine crystal handmade Height/glass: 226 mm Capacity/glass: 380 ccm Design: 1991	Item no.: 4400/0 fine crystal handmade Height/glass: 216 mm Capacity/glass: 350 ccm Design: 1973	Item no.: 4400/28 fine crystal handmade Height/glass: 245 mm Capacity/glass: 330 ccm Design: 1985	Item no.: 4400/08 fine crystal handmade Height/glass: 245 mm Capacity/glass: 170 ccm Design: 1973
PACKAGING TYPE AND QUANTITY	Pieces/Bill unit: 1 Bill units/MP: 4	Pieces/Bill unit: 1 Bill units/MP: 4	Pieces/Bill unit: 1 Bill units/MP: 4	Pieces/Bill unit: 1 Bill units/MP: 4
BILL UNIT DIMENSIONS	Length: 143 mm Width: 128 mm Height: 257 mm Weight: 306 gr	Length: 143 mm Width: 128 mm Height: 257 mm Weight: 296 gr	Length: 143 mm Width: 128 mm Height: 257 mm Weight: 301 gr	Length: 143 mm Width: 128 mm Height: 257 mm Weight: 301 gr
MASTERPACK DIMENSIONS	Length: 292 mm Width: 272 mm Height: 280 mm Weight: 1440 gr	Length: 292 mm Width: 272 mm Height: 280 mm Weight: 1400 gr	Length: 292 mm Width: 272 mm Height: 280 mm Weight: 1420 gr	Length: 292 mm Width: 272 mm Height: 280 mm Weight: 1420 gr
EURO PALLET	Bill units/pallet: 288 Bill units/layer: 48 Layers/pallet: 6	Bill units/pallet: 288 Bill units/layer: 48 Layers/pallet: 6	Bill units/pallet: 288 Bill units/layer: 48 Layers/pallet: 6	Bill units/pallet: 288 Bill units/layer: 48 Layers/pallet: 6
CONTAINER PALLET HIGH CUBE	Bill units/pallet: 384 Bill units/layer: 48 Layers/pallet: 8	Bill units/pallet: 384 Bill units/layer: 48 Layers/pallet: 8	Bill units/pallet: 384 Bill units/layer: 48 Layers/pallet: 8	Bill units/pallet: 384 Bill units/layer: 48 Layers/pallet: 8
EAN BILL UNIT	 9 006206 211876	 9 006206 212026	 9 006206 111602	 9 006206 111589



Champagne Wine Glass



Sparkling Wine



Loire



Riesling Grand Cru

ITEM	Item no.: fine crystal handmade	4400/58	Item no.: fine crystal handmade	4400/88	Item no.: fine crystal handmade	4400/33	Item no.: fine crystal handmade	4400/15
	Height/glass:	235 mm	Height/glass:	215 mm	Height/glass:	235 mm	Height/glass:	226 mm
	Capacity/glass:	445 ccm	Capacity/glass:	125 ccm	Capacity/glass:	350 ccm	Capacity/glass:	380 ccm
	Design:	2020	Design:	1982	Design:	1997	Design:	1991
PACKAGING	Pieces/Bill unit:	1	Pieces/Bill unit:	1	Pieces/Bill unit:	1	Pieces/Bill unit:	1
TYPE AND QUANTITY	Bill units/MP:	4	Bill units/MP:	4	Bill units/MP:	4	Bill units/MP:	4
BILL UNIT	Length:	143 mm	Length:	143 mm	Length:	133 mm	Length:	143 mm
DIMENSIONS	Width:	128 mm	Width:	128 mm	Width:	119 mm	Width:	128 mm
	Height:	257 mm	Height:	257 mm	Height:	292 mm	Height:	257 mm
	Weight:	313 gr	Weight:	271 gr	Weight:	311 gr	Weight:	306 gr
MASTERPACK	Length:	292 mm	Length:	292 mm	Length:	281 mm	Length:	292 mm
DIMENSIONS	Width:	272 mm	Width:	272 mm	Width:	250 mm	Width:	272 mm
	Height:	280 mm	Height:	280 mm	Height:	313 mm	Height:	280 mm
	Weight:	1468 gr	Weight:	1300 gr	Weight:	1456 gr	Weight:	1440 gr
EURO PALLET	Bill units/pallet:	288	Bill units/pallet:	288	Bill units/pallet:	288	Bill units/pallet:	288
	Bill units/layer:	48	Bill units/layer:	48	Bill units/layer:	48	Bill units/layer:	48
	Layers/pallet:	6	Layers/pallet:	6	Layers/pallet:	6	Layers/pallet:	6
CONTAINER PALLET	Bill units/pallet:	384	Bill units/pallet:	384	Bill units/pallet:	448	Bill units/pallet:	384
HIGH CUBE	Bill units/layer:	48	Bill units/layer:	48	Bill units/layer:	64	Bill units/layer:	48
	Layers/pallet:	8	Layers/pallet:	8	Layers/pallet:	7	Layers/pallet:	8
EAN								
BILL UNIT	9 006206 215768		9 006206 210992		9 006206 211944		9 006206 211876	





Chablis/Chardonnay







Rheingau



Montrachet



Sauternes

ITEM	Item no.: 4400/0 fine crystal handmade Height/glass: 216 mm Capacity/glass: 350 ccm Design: 1973	Item no.: 4400/01 fine crystal handmade Height/glass: 206 mm Capacity/glass: 230 ccm Design: 1973	Item no.: 4400/07 fine crystal handmade Height/glass: 200 mm Capacity/glass: 520 ccm Design: 1973	Item no.: 4400/55 fine crystal handmade Height/glass: 200 mm Capacity/glass: 340 ccm Design: 1989
PACKAGING TYPE AND QUANTITY	Pieces/Bill unit: 1 Bill units/MP: 4	Pieces/Bill unit: 1 Bill units/MP: 4	Pieces/Bill unit: 1 Bill units/MP: 4	Pieces/Bill unit: 1 Bill units/MP: 4
BILL UNIT DIMENSIONS	Length: 143 mm Width: 128 mm Height: 257 mm Weight: 296 gr	Length: 133 mm Width: 119 mm Height: 292 mm Weight: 276 gr	Length: 133 mm Width: 119 mm Height: 292 mm Weight: 306 gr	Length: 133 mm Width: 119 mm Height: 292 mm Weight: 296 gr
MASTERPACK DIMENSIONS	Length: 292 mm Width: 272 mm Height: 280 mm Weight: 1400 gr	Length: 281 mm Width: 250 mm Height: 313 mm Weight: 1316 gr	Length: 281 mm Width: 250 mm Height: 313 mm Weight: 1436 gr	Length: 281 mm Width: 250 mm Height: 313 mm Weight: 1396 gr
EURO PALLET	Bill units/pallet: 288 Bill units/layer: 48 Layers/pallet: 6	Bill units/pallet: 288 Bill units/layer: 48 Layers/pallet: 6	Bill units/pallet: 288 Bill units/layer: 48 Layers/pallet: 6	Bill units/pallet: 288 Bill units/layer: 48 Layers/pallet: 6
CONTAINER PALLET HIGH CUBE	Bill units/pallet: 384 Bill units/layer: 48 Layers/pallet: 8	Bill units/pallet: 448 Bill units/layer: 64 Layers/pallet: 7	Bill units/pallet: 448 Bill units/layer: 64 Layers/pallet: 7	Bill units/pallet: 448 Bill units/layer: 64 Layers/pallet: 7
EAN BILL UNIT	 9 006206 212026	 9 006206 211807	 9 006206 211852	 9 006206 211951



Rosé



Water



Blind Blind Tasting Glass



Sherry/Tequila

ITEM	Item no.: fine crystal handmade	4400/04	Item no.: fine crystal handmade	4400/20	Item no.: fine crystal handmade	8400/15	Item no.: fine crystal handmade	4400/18
	Height/glass:	178 mm	Height/glass:	130 mm	Height/glass:	226 mm	Height/glass:	211 mm
	Capacity/glass:	200 ccm	Capacity/glass:	340 ccm	Capacity/glass:	380 ccm	Capacity/glass:	190 ccm
	Design:	1973	Design:	1987	Design:	2003	Design:	1980
PACKAGING	Pieces/Bill unit:	1	Pieces/Bill unit:	1	Pieces/Bill unit:	1	Pieces/Bill unit:	1
TYPE AND QUANTITY	Bill units/MP:	4	Bill units/MP:	4	Bill units/MP:	4	Bill units/MP:	4
BILL UNIT	Length:	133 mm	Length:	143 mm	Length:	143 mm	Length:	133 mm
DIMENSIONS	Width:	119 mm	Width:	128 mm	Width:	128 mm	Width:	119 mm
	Height:	292 mm	Height:	257 mm	Height:	257 mm	Height:	292 mm
	Weight:	286 gr	Weight:	271 gr	Weight:	306 gr	Weight:	291 gr
MASTERPACK	Length:	281 mm	Length:	292 mm	Length:	292 mm	Length:	281 mm
DIMENSIONS	Width:	250 mm	Width:	272 mm	Width:	272 mm	Width:	250 mm
	Height:	313 mm	Height:	280 mm	Height:	280 mm	Height:	313 mm
	Weight:	1356 gr	Weight:	1300 gr	Weight:	1440 gr	Weight:	1376 gr
EURO PALLET	Bill units/pallet:	288	Bill units/pallet:	288	Bill units/pallet:	288	Bill units/pallet:	288
	Bill units/layer:	48	Bill units/layer:	48	Bill units/layer:	48	Bill units/layer:	48
	Layers/pallet:	6	Layers/pallet:	6	Layers/pallet:	6	Layers/pallet:	6
CONTAINER PALLET	Bill units/pallet:	448	Bill units/pallet:	384	Bill units/pallet:	384	Bill units/pallet:	448
HIGH CUBE	Bill units/layer:	64	Bill units/layer:	48	Bill units/layer:	48	Bill units/layer:	64
	Layers/pallet:	7	Layers/pallet:	8	Layers/pallet:	8	Layers/pallet:	7
EAN								
BILL UNIT	9 006206 211821		9 006206 111596		9 006206 212477		9 006206 211906	





Orchard Fruit







Stone Fruit



Grappa



Martini

ITEM	Item no.: 4200/04 fine crystal handmade	Item no.: 4200/06 fine crystal handmade	Item no.: 4200/03 fine crystal handmade	Item no.: 4400/17 fine crystal handmade
	Height/glass: 200 mm Capacity/glass: 125 ccm Design: 1984	Height/glass: 200 mm Capacity/glass: 180 ccm Design: 1984	Height/glass: 200 mm Capacity/glass: 110 ccm Design: 1984	Height/glass: 182 mm Capacity/glass: 210 ccm Design: 1982
PACKAGING TYPE AND QUANTITY	Pieces/Bill unit: 1 Bill units/MP: 4	Pieces/Bill unit: 1 Bill units/MP: 4	Pieces/Bill unit: 1 Bill units/MP: 4	Pieces/Bill unit: 1 Bill units/MP: 4
BILL UNIT DIMENSIONS	Length: 133 mm Width: 119 mm Height: 292 mm Weight: 266 gr	Length: 133 mm Width: 119 mm Height: 292 mm Weight: 266 gr	Length: 133 mm Width: 119 mm Height: 292 mm Weight: 266 gr	Length: 143 mm Width: 128 mm Height: 257 mm Weight: 306 gr
MASTERPACK DIMENSIONS	Length: 281 mm Width: 250 mm Height: 313 mm Weight: 1276 gr	Length: 281 mm Width: 250 mm Height: 313 mm Weight: 1276 gr	Length: 281 mm Width: 250 mm Height: 313 mm Weight: 1276 gr	Length: 292 mm Width: 272 mm Height: 280 mm Weight: 1440 gr
EURO PALLET	Bill units/pallet: 288 Bill units/layer: 48 Layers/pallet: 6	Bill units/pallet: 288 Bill units/layer: 48 Layers/pallet: 6	Bill units/pallet: 288 Bill units/layer: 48 Layers/pallet: 6	Bill units/pallet: 288 Bill units/layer: 48 Layers/pallet: 6
CONTAINER PALLET HIGH CUBE	Bill units/pallet: 448 Bill units/layer: 64 Layers/pallet: 7	Bill units/pallet: 448 Bill units/layer: 64 Layers/pallet: 7	Bill units/pallet: 448 Bill units/layer: 64 Layers/pallet: 7	Bill units/pallet: 384 Bill units/layer: 48 Layers/pallet: 8
EAN BILL UNIT	 9 006206 111558	 9 006206 111572	 9 006206 111541	 9 006206 211890



Vintage Port



Cognac XO



Cognac V.S.O.P.



Single Malt Whisky

ITEM	Item no.: 4400/60 fine crystal handmade Height/glass: 172 mm Capacity/glass: 250 ccm Design: 1992	Item no.: 4400/70 fine crystal handmade Height/glass: 165 mm Capacity/glass: 170 ccm Design: 1989	Item no.: 4400/71 fine crystal handmade Height/glass: 165 mm Capacity/glass: 160 ccm Design: 1989	Item no.: 4400/80 fine crystal handmade Height/glass: 115 mm Capacity/glass: 200 ccm Design: 1992
PACKAGING TYPE AND QUANTITY	Pieces/Bill unit: 1 Bill units/MP: 4	Pieces/Bill unit: 1 Bill units/MP: 4	Pieces/Bill unit: 1 Bill units/MP: 4	Pieces/Bill unit: 1 Bill units/MP: 4
BILL UNIT DIMENSIONS	Length: 90 mm Width: 90 mm Height: 205 mm Weight: 220 gr	Length: 143 mm Width: 128 mm Height: 257 mm Weight: 261 gr	Length: 143 mm Width: 128 mm Height: 257 mm Weight: 261 gr	Length: 143 mm Width: 128 mm Height: 257 mm Weight: 261 gr
MASTERPACK DIMENSIONS	Length: 193 mm Width: 193 mm Height: 218 mm Weight: 989 gr	Length: 292 mm Width: 272 mm Height: 280 mm Weight: 1260 gr	Length: 292 mm Width: 272 mm Height: 280 mm Weight: 1260 gr	Length: 292 mm Width: 272 mm Height: 280 mm Weight: 1260 gr
EURO PALLET	Bill units/pallet: 768 Bill units/layer: 96 Layers/pallet: 8	Bill units/pallet: 288 Bill units/layer: 48 Layers/pallet: 6	Bill units/pallet: 288 Bill units/layer: 48 Layers/pallet: 6	Bill units/pallet: 288 Bill units/layer: 48 Layers/pallet: 6
CONTAINER PALLET HIGH CUBE	Bill units/pallet: 1440 Bill units/layer: 120 Layers/pallet: 12	Bill units/pallet: 384 Bill units/layer: 48 Layers/pallet: 8	Bill units/pallet: 384 Bill units/layer: 48 Layers/pallet: 8	Bill units/pallet: 384 Bill units/layer: 48 Layers/pallet: 8
EAN BILL UNIT				



RIEDEL
50 YEARS
sommeliers
— SINCE 1973 —

HANDMADE





sommeliers black tie

SOMMELIERS BLACK TIE (2008)

- SOPHISTICATED AND REFINED
- DISHWASHER SAFE

This range was launched in 2008 to celebrate the 50th anniversary of the iconic SOMMELIERS Burgundy Grand Cru glass. The red wine glasses are distinguished by a tall black stem and the white wine glasses feature a black base, making this one of our most exciting collections.



Bordeaux Grand Cru



Burgundy Grand Cru



Hermitage



Mature Bordeaux

ITEM	Item no.:	4100/00	Item no.:	4100/16	Item no.:	4100/30	Item no.:	4100/0
	fine crystal handmade		fine crystal handmade		fine crystal handmade		fine crystal handmade	
	Height/glass:	282 mm	Height/glass:	276 mm	Height/glass:	265 mm	Height/glass:	242 mm
	Capacity/glass:	860 ccm	Capacity/glass:	1050 ccm	Capacity/glass:	590 ccm	Capacity/glass:	350 ccm
	Design:	2008	Design:	2008	Design:	2008	Design:	2008
PACKAGING TYPE AND QUANTITY	Pieces/Bill unit:	1	Pieces/Bill unit:	1	Pieces/Bill unit:	1	Pieces/Bill unit:	1
	Bill units/MP:	4	Bill units/MP:	4	Bill units/MP:	4	Bill units/MP:	4
BILL UNIT DIMENSIONS	Length:	146 mm	Length:	146 mm	Length:	146 mm	Length:	146 mm
	Width:	133 mm	Width:	133 mm	Width:	133 mm	Width:	133 mm
	Height:	327 mm	Height:	327 mm	Height:	327 mm	Height:	327 mm
	Weight:	378 gr	Weight:	388 gr	Weight:	373 gr	Weight:	328 gr
MASTERPACK DIMENSIONS	Length:	304 mm	Length:	304 mm	Length:	304 mm	Length:	304 mm
	Width:	286 mm	Width:	286 mm	Width:	286 mm	Width:	286 mm
	Height:	343 mm	Height:	343 mm	Height:	343 mm	Height:	343 mm
	Weight:	1772 gr	Weight:	1812 gr	Weight:	1752 gr	Weight:	1572 gr
EURO PALLET	Bill units/pallet:	192	Bill units/pallet:	192	Bill units/pallet:	192	Bill units/pallet:	192
	Bill units/layer:	32	Bill units/layer:	32	Bill units/layer:	32	Bill units/layer:	32
	Layers/pallet:	6	Layers/pallet:	6	Layers/pallet:	6	Layers/pallet:	6
CONTAINER PALLET HIGH CUBE	Bill units/pallet:	288	Bill units/pallet:	288	Bill units/pallet:	288	Bill units/pallet:	288
	Bill units/layer:	48	Bill units/layer:	48	Bill units/layer:	48	Bill units/layer:	48
	Layers/pallet:	6	Layers/pallet:	6	Layers/pallet:	6	Layers/pallet:	6
EAN BILL UNIT								
	9 006206 212811		9 006206 212828		9 006206 212835		9 006206 212842	



SINCE 2008



Vintage Champagne Glass



Riesling Grand Cru



Montrachet

ITEM	Item no.:	4100/28	Item no.:	4100/15	Item no.:	4100/07
	fine crystal handmade		fine crystal handmade		fine crystal handmade	
	Height/glass:	262 mm	Height/glass:	252 mm	Height/glass:	229 mm
	Capacity/glass:	330 ccm	Capacity/glass:	380 ccm	Capacity/glass:	500 ccm
	Design:	2008	Design:	2008	Design:	2008
PACKAGING TYPE AND QUANTITY	Pieces/Bill unit:	1	Pieces/Bill unit:	1	Pieces/Bill unit:	1
	Bill units/MP:	4	Bill units/MP:	4	Bill units/MP:	4
BILL UNIT DIMENSIONS	Length:	146 mm	Length:	146 mm	Length:	146 mm
	Width:	133 mm	Width:	133 mm	Width:	133 mm
	Height:	327 mm	Height:	327 mm	Height:	327 mm
	Weight:	333 gr	Weight:	338 gr	Weight:	343 gr
MASTERPACK DIMENSIONS	Length:	304 mm	Length:	304 mm	Length:	304 mm
	Width:	286 mm	Width:	286 mm	Width:	286 mm
	Height:	343 mm	Height:	343 mm	Height:	343 mm
	Weight:	1592 gr	Weight:	1612 gr	Weight:	1632 gr
EURO PALLET	Bill units/pallet:	192	Bill units/pallet:	192	Bill units/pallet:	192
	Bill units/layer:	32	Bill units/layer:	32	Bill units/layer:	32
	Layers/pallet:	6	Layers/pallet:	6	Layers/pallet:	6
CONTAINER PALLET HIGH CUBE	Bill units/pallet:	288	Bill units/pallet:	288	Bill units/pallet:	288
	Bill units/layer:	48	Bill units/layer:	48	Bill units/layer:	48
	Layers/pallet:	6	Layers/pallet:	6	Layers/pallet:	6
EAN BILL UNIT	 9 006206 212880		 9 006206 212897		 9 006206 212866	

sommeliers black series

BLACK SERIES COLLECTOR'S EDITION (2013)

- RIEDEL'S CLASSIC
- EXCLUSIVE COLLECTOR'S EDITION

To celebrate the 40th anniversary of the Sommeliers glass series, RIEDEL presents an exclusive collector's editions: Pleasure and design objects that emphasize the unique design language of the wine-friendly Sommeliers.

Black Series Collector's Edition is handmade in crystal glass.





HANDMADE



Bordeaux Grand Cru



Burgundy Grand Cru



Sparkling Wine



Riesling Grand Cru

ITEM	Item no.: fine crystal handmade	4100/00R	Item no.: fine crystal handmade	4100/16R	Item no.: fine crystal handmade	4100/08R	Item no.: fine crystal handmade	4100/15R
	Height/glass:	282 mm	Height/glass:	276 mm	Height/glass:	276 mm	Height/glass:	252 mm
	Capacity/glass:	860 ccm	Capacity/glass:	1050 ccm	Capacity/glass:	170 ccm	Capacity/glass:	380 ccm
	Design:	2013	Design:	2013	Design:	2013	Design:	2013
PACKAGING	Pieces/Bill unit:	1	Pieces/Bill unit:	1	Pieces/Bill unit:	1	Pieces/Bill unit:	1
TYPE AND QUANTITY	Bill units/MP:	4	Bill units/MP:	4	Bill units/MP:	4	Bill units/MP:	4
BILL UNIT	Length:	146 mm	Length:	146 mm	Length:	146 mm	Length:	146 mm
DIMENSIONS	Width:	133 mm	Width:	133 mm	Width:	133 mm	Width:	133 mm
	Height:	327 mm	Height:	327 mm	Height:	327 mm	Height:	327 mm
	Weight:	378 gr	Weight:	388 gr	Weight:	333 gr	Weight:	338 gr
MASTERPACK	Length:	304 mm	Length:	304 mm	Length:	304 mm	Length:	304 mm
DIMENSIONS	Width:	286 mm	Width:	286 mm	Width:	286 mm	Width:	286 mm
	Height:	343 mm	Height:	343 mm	Height:	343 mm	Height:	343 mm
	Weight:	1772 gr	Weight:	1812 gr	Weight:	1592 gr	Weight:	1612 gr
EURO PALLET	Bill units/pallet:	192	Bill units/pallet:	192	Bill units/pallet:	192	Bill units/pallet:	192
	Bill units/layer:	32	Bill units/layer:	32	Bill units/layer:	32	Bill units/layer:	32
	Layers/pallet:	6	Layers/pallet:	6	Layers/pallet:	6	Layers/pallet:	6
CONTAINER PALLET	Bill units/pallet:	288	Bill units/pallet:	288	Bill units/pallet:	288	Bill units/pallet:	288
HIGH CUBE	Bill units/layer:	48	Bill units/layer:	48	Bill units/layer:	48	Bill units/layer:	48
	Layers/pallet:	6	Layers/pallet:	6	Layers/pallet:	6	Layers/pallet:	6
EAN								
BILL UNIT	9 006206 213610		9 006206 213627		9 006206 213634		9 006206 213641	



SINCE 2013



Montrachet

ITEM	Item no.: 4100/07R fine crystal handmade
	Height/glass: 229 mm Capacity/glass: 500 ccm Design: 2013
PACKAGING	Pieces/Bill unit: 1
TYPE AND QUANTITY	Bill units/MP: 4
BILL UNIT	Length: 146 mm
DIMENSIONS	Width: 133 mm Height: 327 mm Weight: 343 gr
MASTERPACK	Length: 304 mm
DIMENSIONS	Width: 286 mm Height: 343 mm Weight: 1632 gr
EURO PALLET	Bill units/pallet: 192 Bill units/layer: 32 Layers/pallet: 6
CONTAINER PALLET	Bill units/pallet: 288
HIGH CUBE	Bill units/layer: 48 Layers/pallet: 6
EAN	 9 006206 213658
BILL UNIT	



HANDMADE

RIEDEL HIGH PERFORMANCE

RIEDEL HIGH PERFORMANCE (2020)

- OPTIC IMPACT
- XL STEM

The machine-produced visual effect has a positive impact on the taste experience: not only does it give the chalice an attractive appearance, it also increases the internal surface area. This allows the champagne to open up and bring out its full aroma, with all its subtle nuances. The long drawn stems are a masterpiece of the glassmaker's art. They give the glass an exclusive, unique elegance.





HANDMADE



Champagne Glass



Champagne Glass
Black



Champagne Glass
Red



Champagne Glass
Dark Blue

ITEM	Item no.: 4994/28 fine crystal handmade	Item no.: 4994/28B fine crystal handmade	Item no.: 4994/28R fine crystal handmade	Item no.: 4994/28D fine crystal handmade
	Height/glass: 325 mm	Height/glass: 325 mm	Height/glass: 325 mm	Height/glass: 325 mm
	Capacity/glass: 375 ccm	Capacity/glass: 375 ccm	Capacity/glass: 375 ccm	Capacity/glass: 375 ccm
	Design: 2020	Design: 2020	Design: 2020	Design: 2022
PACKAGING	Pieces/Bill unit: 1	Pieces/Bill unit: 1	Pieces/Bill unit: 1	Pieces/Bill unit: 1
TYPE AND QUANTITY	Bill units/MP: 4	Bill units/MP: 4	Bill units/MP: 4	Bill units/MP: 4
BILL UNIT	Length: 126 mm	Length: 126 mm	Length: 126 mm	Length: 126 mm
DIMENSIONS	Width: 126 mm	Width: 126 mm	Width: 126 mm	Width: 126 mm
	Height: 365 mm	Height: 365 mm	Height: 365 mm	Height: 365 mm
	Weight: 265 gr	Weight: 265 gr	Weight: 265 gr	Weight: 265 gr
MASTERPACK	Length: 522 mm	Length: 522 mm	Length: 522 mm	Length: 522 mm
DIMENSIONS	Width: 294 mm	Width: 294 mm	Width: 294 mm	Width: 294 mm
	Height: 300 mm	Height: 300 mm	Height: 300 mm	Height: 300 mm
	Weight: 1337 gr	Weight: 1337 gr	Weight: 1337 gr	Weight: 1337 gr
EURO PALLET	Bill units/pallet: 160	Bill units/pallet: 160	Bill units/pallet: 160	Bill units/pallet: 160
	Bill units/layer: 32	Bill units/layer: 32	Bill units/layer: 32	Bill units/layer: 32
	Layers/pallet: 5	Layers/pallet: 5	Layers/pallet: 5	Layers/pallet: 5
CONTAINER PALLET	Bill units/pallet: 360	Bill units/pallet: 360	Bill units/pallet: 360	Bill units/pallet: 360
HIGH CUBE	Bill units/layer: 60	Bill units/layer: 60	Bill units/layer: 60	Bill units/layer: 60
	Layers/pallet: 6	Layers/pallet: 6	Layers/pallet: 6	Layers/pallet: 6
EAN				
BILL UNIT	9 006206 215898	9 006206 215904	9 006206 215911	9 006206 324064



SINCE 2020



Champagne Glass
Pink



Champagne Glass
Yellow

ITEM	Item no.:	4994/28P	Item no.:	4994/28Y
	fine crystal handmade		fine crystal handmade	
	Height/glass:	325 mm	Height/glass:	325 mm
	Capacity/glass:	375 ccm	Capacity/glass:	375 ccm
	Design:	2022	Design:	2022
PACKAGING TYPE AND QUANTITY	Pieces/Bill unit:	1	Pieces/Bill unit:	1
	Bill units/MP:	4	Bill units/MP:	4
BILL UNIT DIMENSIONS	Length:	126 mm	Length:	126 mm
	Width:	126 mm	Width:	126 mm
	Height:	365 mm	Height:	365 mm
	Weight:	265 gr	Weight:	265 gr
MASTERPACK DIMENSIONS	Length:	522 mm	Length:	522 mm
	Width:	294 mm	Width:	294 mm
	Height:	300 mm	Height:	300 mm
	Weight:	1337 gr	Weight:	1337 gr
EURO PALLET	Bill units/pallet:	160	Bill units/pallet:	160
	Bill units/layer:	32	Bill units/layer:	32
	Layers/pallet:	5	Layers/pallet:	5
CONTAINER PALLET HIGH CUBE	Bill units/pallet:	360	Bill units/pallet:	360
	Bill units/layer:	60	Bill units/layer:	60
	Layers/pallet:	6	Layers/pallet:	6
EAN BILL UNIT				





FATTO A MANO
performance

RIEDEL FATTO A MANO PERFORMANCE (2019)
SPECTACULAR AND GRACEFUL
WITH THE OPTIC IMPACT

First presented in 2019 RIEDEL FATTO A MANO PERFORMANCE is a combination of two successful series and marries refined craftsmanship (for the stem and the base) and the precision of a machine (for the bowl). RIEDEL FATTO A MANO PERFORMANCE consists of four parts and is produced in the factory in Kufstein. The glasses in this series are made of crystal glass.



Cabernet Sauvignon
Black stem



Cabernet Sauvignon
Clear stem



Cabernet Sauvignon
Red stem



Pinot Noir
Black stem

ITEM	Item no.: 4884/0D fine crystal handmade	Item no.: 4884/0N fine crystal handmade	Item no.: 4884/OR fine crystal handmade	Item no.: 4884/67D fine crystal handmade
	Height/glass: 250 mm	Height/glass: 250 mm	Height/glass: 250 mm	Height/glass: 250 mm
	Capacity/glass: 834 ccm	Capacity/glass: 834 ccm	Capacity/glass: 834 ccm	Capacity/glass: 830 ccm
	Design: 2019	Design: 2019	Design: 2020	Design: 2019
PACKAGING	Pieces/Bill unit: 1	Pieces/Bill unit: 1	Pieces/Bill unit: 1	Pieces/Bill unit: 1
TYPE AND QUANTITY	Bill units/MP: 4	Bill units/MP: 4	Bill units/MP: 4	Bill units/MP: 4
BILL UNIT	Length: 146 mm	Length: 146 mm	Length: 146 mm	Length: 146 mm
DIMENSIONS	Width: 133 mm	Width: 133 mm	Width: 133 mm	Width: 133 mm
	Height: 327 mm	Height: 327 mm	Height: 327 mm	Height: 327 mm
	Weight: 363 gr	Weight: 363 gr	Weight: 363 gr	Weight: 383 gr
MASTERPACK	Length: 304 mm	Length: 304 mm	Length: 304 mm	Length: 304 mm
DIMENSIONS	Width: 286 mm	Width: 286 mm	Width: 286 mm	Width: 286 mm
	Height: 343 mm	Height: 343 mm	Height: 343 mm	Height: 343 mm
	Weight: 1712 gr	Weight: 1712 gr	Weight: 1712 gr	Weight: 1792 gr
EURO PALLET	Bill units/pallet: 96	Bill units/pallet: 96	Bill units/pallet: 96	Bill units/pallet: 96
	Bill units/layer: 32	Bill units/layer: 32	Bill units/layer: 32	Bill units/layer: 32
	Layers/pallet: 3	Layers/pallet: 3	Layers/pallet: 3	Layers/pallet: 3
CONTAINER PALLET	Bill units/pallet: 288	Bill units/pallet: 288	Bill units/pallet: 288	Bill units/pallet: 288
HIGH CUBE	Bill units/layer: 48	Bill units/layer: 48	Bill units/layer: 48	Bill units/layer: 48
	Layers/pallet: 6	Layers/pallet: 6	Layers/pallet: 6	Layers/pallet: 6
EAN BILL UNIT				



SINCE 2019





Pinot Noir
Clear stem



Pinot Noir
Red stem



Champagne Glass
Black stem



Champagne Glass
Clear stem

ITEM	Item no.: 4884/67N fine crystal handmade	Item no.: 4884/67R fine crystal handmade	Item no.: 4884/28D fine crystal handmade	Item no.: 4884/28N fine crystal handmade
	Height/glass: 250 mm Capacity/glass: 830 ccm Design: 2019	Height/glass: 250 mm Capacity/glass: 830 ccm Design: 2020	Height/glass: 250 mm Capacity/glass: 375 ccm Design: 2019	Height/glass: 250 mm Capacity/glass: 375 ccm Design: 2019
PACKAGING	Pieces/Bill unit: 1	Pieces/Bill unit: 1	Pieces/Bill unit: 1	Pieces/Bill unit: 1
TYPE AND QUANTITY	Bill units/MP: 4	Bill units/MP: 4	Bill units/MP: 4	Bill units/MP: 4
BILL UNIT	Length: 146 mm	Length: 146 mm	Length: 146 mm	Length: 146 mm
DIMENSIONS	Width: 133 mm	Width: 133 mm	Width: 133 mm	Width: 133 mm
	Height: 327 mm	Height: 327 mm	Height: 327 mm	Height: 327 mm
	Weight: 383 gr	Weight: 383 gr	Weight: 348 gr	Weight: 348 gr
MASTERPACK	Length: 304 mm	Length: 304 mm	Length: 304 mm	Length: 304 mm
DIMENSIONS	Width: 286 mm	Width: 286 mm	Width: 286 mm	Width: 286 mm
	Height: 343 mm	Height: 343 mm	Height: 343 mm	Height: 343 mm
	Weight: 1792 gr	Weight: 1792 gr	Weight: 1652 gr	Weight: 1652 gr
EURO PALLET	Bill units/pallet: 96	Bill units/pallet: 96	Bill units/pallet: 96	Bill units/pallet: 96
	Bill units/layer: 32	Bill units/layer: 32	Bill units/layer: 32	Bill units/layer: 32
	Layers/pallet: 3	Layers/pallet: 3	Layers/pallet: 3	Layers/pallet: 3
CONTAINER PALLET	Bill units/pallet: 288	Bill units/pallet: 288	Bill units/pallet: 288	Bill units/pallet: 288
HIGH CUBE	Bill units/layer: 48	Bill units/layer: 48	Bill units/layer: 48	Bill units/layer: 48
	Layers/pallet: 6	Layers/pallet: 6	Layers/pallet: 6	Layers/pallet: 6
EAN				
BILL UNIT	9 006206 215379	9 006206 215744	9 006206 215409	9 006206 215393





Champagne Glass
Red stem



Riesling
Black stem



Riesling
Clear stem



Riesling
Red stem

ITEM	Item no.: 4884/28R	Item no.: 4884/15D	Item no.: 4884/15N	Item no.: 4884/15R
	fine crystal handmade	fine crystal handmade	fine crystal handmade	fine crystal handmade
	Height/glass: 250 mm Capacity/glass: 375 ccm Design: 2020	Height/glass: 250 mm Capacity/glass: 623 ccm Design: 2019	Height/glass: 250 mm Capacity/glass: 623 ccm Design: 2019	Height/glass: 250 mm Capacity/glass: 623 ccm Design: 2020
PACKAGING TYPE AND QUANTITY	Pieces/Bill unit: 1	Pieces/Bill unit: 1	Pieces/Bill unit: 1	Pieces/Bill unit: 1
	Bill units/MP: 4	Bill units/MP: 4	Bill units/MP: 4	Bill units/MP: 4
BILL UNIT DIMENSIONS	Length: 146 mm	Length: 146 mm	Length: 146 mm	Length: 146 mm
	Width: 133 mm	Width: 133 mm	Width: 133 mm	Width: 133 mm
	Height: 327 mm	Height: 327 mm	Height: 327 mm	Height: 327 mm
	Weight: 348 gr	Weight: 358 gr	Weight: 358 gr	Weight: 358 gr
MASTERPACK DIMENSIONS	Length: 304 mm	Length: 304 mm	Length: 304 mm	Length: 304 mm
	Width: 286 mm	Width: 286 mm	Width: 286 mm	Width: 286 mm
	Height: 343 mm	Height: 343 mm	Height: 343 mm	Height: 343 mm
	Weight: 1652 gr	Weight: 1692 gr	Weight: 1692 gr	Weight: 1692 gr
EURO PALLET	Bill units/pallet: 96	Bill units/pallet: 96	Bill units/pallet: 96	Bill units/pallet: 96
	Bill units/layer: 32	Bill units/layer: 32	Bill units/layer: 32	Bill units/layer: 32
	Layers/pallet: 3	Layers/pallet: 3	Layers/pallet: 3	Layers/pallet: 3
CONTAINER PALLET HIGH CUBE	Bill units/pallet: 288	Bill units/pallet: 288	Bill units/pallet: 288	Bill units/pallet: 288
	Bill units/layer: 48	Bill units/layer: 48	Bill units/layer: 48	Bill units/layer: 48
	Layers/pallet: 6	Layers/pallet: 6	Layers/pallet: 6	Layers/pallet: 6
EAN BILL UNIT				





FATTO A MANO

by Riedel

HANDMADE



RIEDEL FATTO A MANO (2017) COLOURFUL VENETIAN TRADITION

This collection is a stunning range of varietal-specific wine glasses with colourful handmade stems using traditional Venetian techniques. With its hand-made stem and base, „Fatto a Mano” combines the crafts of the past with today’s technologically-advanced, machine blown techniques. The finished product charms the eye with its hand-crafted feel, colorful aesthetics and varietal specific bowls.



Cabernet/Merlot
Mauve



Cabernet/Merlot
Mint



Cabernet/Merlot
Orange



Cabernet/Merlot
Turquoise

ITEM	Item no.: fine crystal handmade	4900/OMA	Item no.: fine crystal handmade	4900/OM	Item no.: fine crystal handmade	4900/OO	Item no.: fine crystal handmade	4900/OT
	Height/glass:	250 mm	Height/glass:	250 mm	Height/glass:	250 mm	Height/glass:	250 mm
	Capacity/glass:	625 ccm	Capacity/glass:	625 ccm	Capacity/glass:	625 ccm	Capacity/glass:	625 ccm
	Design:	2022	Design:	2022	Design:	2022	Design:	2022
PACKAGING	Pieces/Bill unit:	1	Pieces/Bill unit:	1	Pieces/Bill unit:	1	Pieces/Bill unit:	1
TYPE AND QUANTITY	Bill units/MP:	4	Bill units/MP:	4	Bill units/MP:	4	Bill units/MP:	4
BILL UNIT	Length:	146 mm	Length:	146 mm	Length:	146 mm	Length:	146 mm
DIMENSIONS	Width:	133 mm	Width:	133 mm	Width:	133 mm	Width:	133 mm
	Height:	327 mm	Height:	327 mm	Height:	327 mm	Height:	327 mm
	Weight:	373 gr	Weight:	373 gr	Weight:	373 gr	Weight:	373 gr
MASTERPACK	Length:	304 mm	Length:	304 mm	Length:	304 mm	Length:	304 mm
DIMENSIONS	Width:	286 mm	Width:	286 mm	Width:	286 mm	Width:	286 mm
	Height:	343 mm	Height:	343 mm	Height:	343 mm	Height:	343 mm
	Weight:	1752 gr	Weight:	1752 gr	Weight:	1752 gr	Weight:	1752 gr
EURO PALLET	Bill units/pallet:	96	Bill units/pallet:	96	Bill units/pallet:	96	Bill units/pallet:	96
	Bill units/layer:	32	Bill units/layer:	32	Bill units/layer:	32	Bill units/layer:	32
	Layers/pallet:	3	Layers/pallet:	3	Layers/pallet:	3	Layers/pallet:	3
CONTAINER PALLET	Bill units/pallet:	288	Bill units/pallet:	288	Bill units/pallet:	288	Bill units/pallet:	288
HIGH CUBE	Bill units/layer:	48	Bill units/layer:	48	Bill units/layer:	48	Bill units/layer:	48
	Layers/pallet:	6	Layers/pallet:	6	Layers/pallet:	6	Layers/pallet:	6
EAN								
BILL UNIT	9 006206 323500		9 006206 323623		9 006206 215331		9 006206 323562	





Cabernet/Merlot
White







Cabernet/Merlot
Yellow



Cabernet/Merlot
Red



Cabernet/Merlot
Dark Blue

ITEM	Item no.: fine crystal handmade	4900/0W	Item no.: fine crystal handmade	4900/0Y	Item no.: fine crystal handmade	4900/0R	Item no.: fine crystal handmade	4900/0D
	Height/glass:	250 mm	Height/glass:	250 mm	Height/glass:	250 mm	Height/glass:	250 mm
	Capacity/glass:	625 ccm	Capacity/glass:	625 ccm	Capacity/glass:	625 ccm	Capacity/glass:	625 ccm
	Design:	2017	Design:	2017	Design:	2017	Design:	2017
PACKAGING	Pieces/Bill unit:	1	Pieces/Bill unit:	1	Pieces/Bill unit:	1	Pieces/Bill unit:	1
TYPE AND QUANTITY	Bill units/MP:	4	Bill units/MP:	4	Bill units/MP:	4	Bill units/MP:	4
BILL UNIT	Length:	146 mm	Length:	146 mm	Length:	146 mm	Length:	146 mm
DIMENSIONS	Width:	133 mm	Width:	133 mm	Width:	133 mm	Width:	133 mm
	Height:	327 mm	Height:	327 mm	Height:	327 mm	Height:	327 mm
	Weight:	373 gr	Weight:	373 gr	Weight:	373 gr	Weight:	373 gr
MASTERPACK	Length:	304 mm	Length:	304 mm	Length:	304 mm	Length:	304 mm
DIMENSIONS	Width:	286 mm	Width:	286 mm	Width:	286 mm	Width:	286 mm
	Height:	343 mm	Height:	343 mm	Height:	343 mm	Height:	343 mm
	Weight:	1752 gr	Weight:	1752 gr	Weight:	1752 gr	Weight:	1752 gr
EURO PALLET	Bill units/pallet:	96	Bill units/pallet:	96	Bill units/pallet:	96	Bill units/pallet:	96
	Bill units/layer:	32	Bill units/layer:	32	Bill units/layer:	32	Bill units/layer:	32
	Layers/pallet:	3	Layers/pallet:	3	Layers/pallet:	3	Layers/pallet:	3
CONTAINER PALLET	Bill units/pallet:	288	Bill units/pallet:	288	Bill units/pallet:	288	Bill units/pallet:	288
HIGH CUBE	Bill units/layer:	48	Bill units/layer:	48	Bill units/layer:	48	Bill units/layer:	48
	Layers/pallet:	6	Layers/pallet:	6	Layers/pallet:	6	Layers/pallet:	6
EAN	 9 006206 214723		 9 006206 214730		 9 006206 214747		 9 006206 214754	
BILL UNIT								



Cabernet/Merlot
Green



Cabernet/Merlot
Black



Cabernet/Merlot
Pink



Cabernet/Merlot
Opal Violet

ITEM	Item no.: 4900/0G fine crystal handmade	Item no.: 4900/0B fine crystal handmade	Item no.: 4900/0P fine crystal handmade	Item no.: 4900/0V fine crystal handmade
	Height/glass: 250 mm Capacity/glass: 625 ccm Design: 2017	Height/glass: 250 mm Capacity/glass: 625 ccm Design: 2017	Height/glass: 250 mm Capacity/glass: 625 ccm Design: 2018	Height/glass: 250 mm Capacity/glass: 625 ccm Design: 2020
PACKAGING	Pieces/Bill unit: 1	Pieces/Bill unit: 1	Pieces/Bill unit: 1	Pieces/Bill unit: 1
TYPE AND QUANTITY	Bill units/MP: 4	Bill units/MP: 4	Bill units/MP: 4	Bill units/MP: 4
BILL UNIT	Length: 146 mm	Length: 146 mm	Length: 146 mm	Length: 146 mm
DIMENSIONS	Width: 133 mm	Width: 133 mm	Width: 133 mm	Width: 133 mm
	Height: 327 mm	Height: 327 mm	Height: 327 mm	Height: 327 mm
	Weight: 373 gr	Weight: 373 gr	Weight: 373 gr	Weight: 373 gr
MASTERPACK	Length: 304 mm	Length: 304 mm	Length: 304 mm	Length: 304 mm
DIMENSIONS	Width: 286 mm	Width: 286 mm	Width: 286 mm	Width: 286 mm
	Height: 343 mm	Height: 343 mm	Height: 343 mm	Height: 343 mm
	Weight: 1752 gr	Weight: 1752 gr	Weight: 1752 gr	Weight: 1752 gr
EURO PALLET	Bill units/pallet: 96	Bill units/pallet: 96	Bill units/pallet: 96	Bill units/pallet: 96
	Bill units/layer: 32	Bill units/layer: 32	Bill units/layer: 32	Bill units/layer: 32
	Layers/pallet: 3	Layers/pallet: 3	Layers/pallet: 3	Layers/pallet: 3
CONTAINER PALLET	Bill units/pallet: 288	Bill units/pallet: 288	Bill units/pallet: 288	Bill units/pallet: 288
HIGH CUBE	Bill units/layer: 48	Bill units/layer: 48	Bill units/layer: 48	Bill units/layer: 48
	Layers/pallet: 6	Layers/pallet: 6	Layers/pallet: 6	Layers/pallet: 6
EAN				
BILL UNIT	9 006206 214761	9 006206 214778	9 006206 215034	9 006206 215270



Pinot Noir
Mauve



Pinot Noir
Mint



Pinot Noir
Orange



Pinot Noir
Turquoise

ITEM	Item no.: 4900/07MA fine crystal handmade	Item no.: 4900/07M fine crystal handmade	Item no.: 4900/07O fine crystal handmade	Item no.: 4900/07T fine crystal handmade
	Height/glass: 250 mm Capacity/glass: 705 ccm Design: 2022	Height/glass: 250 mm Capacity/glass: 705 ccm Design: 2022	Height/glass: 250 mm Capacity/glass: 705 ccm Design: 2022	Height/glass: 250 mm Capacity/glass: 705 ccm Design: 2022
PACKAGING	Pieces/Bill unit: 1	Pieces/Bill unit: 1	Pieces/Bill unit: 1	Pieces/Bill unit: 1
TYPE AND QUANTITY	Bill units/MP: 4	Bill units/MP: 4	Bill units/MP: 4	Bill units/MP: 4
BILL UNIT	Length: 146 mm	Length: 146 mm	Length: 146 mm	Length: 146 mm
DIMENSIONS	Width: 133 mm	Width: 133 mm	Width: 133 mm	Width: 133 mm
	Height: 327 mm	Height: 327 mm	Height: 327 mm	Height: 327 mm
	Weight: 373 gr	Weight: 373 gr	Weight: 373 gr	Weight: 373 gr
MASTERPACK	Length: 304 mm	Length: 304 mm	Length: 304 mm	Length: 304 mm
DIMENSIONS	Width: 286 mm	Width: 286 mm	Width: 286 mm	Width: 286 mm
	Height: 343 mm	Height: 343 mm	Height: 343 mm	Height: 343 mm
	Weight: 1752 gr	Weight: 1752 gr	Weight: 1752 gr	Weight: 1752 gr
EURO PALLET	Bill units/pallet: 96	Bill units/pallet: 96	Bill units/pallet: 96	Bill units/pallet: 96
	Bill units/layer: 32	Bill units/layer: 32	Bill units/layer: 32	Bill units/layer: 32
	Layers/pallet: 3	Layers/pallet: 3	Layers/pallet: 3	Layers/pallet: 3
CONTAINER PALLET	Bill units/pallet: 288	Bill units/pallet: 288	Bill units/pallet: 288	Bill units/pallet: 288
HIGH CUBE	Bill units/layer: 48	Bill units/layer: 48	Bill units/layer: 48	Bill units/layer: 48
	Layers/pallet: 6	Layers/pallet: 6	Layers/pallet: 6	Layers/pallet: 6
EAN				
BILL UNIT	9 006206 323517	9 006206 323630	9 006206 215324	9 006206 323579





Pinot Noir
White



Pinot Noir
Yellow



Pinot Noir
Red



Pinot Noir Dark
Blue

ITEM	Item no.: 4900/07W fine crystal handmade	Item no.: 4900/07Y fine crystal handmade	Item no.: 4900/07R fine crystal handmade	Item no.: 4900/07D fine crystal handmade
	Height/glass: 250 mm Capacity/glass: 705 ccm Design: 2017	Height/glass: 250 mm Capacity/glass: 705 ccm Design: 2017	Height/glass: 250 mm Capacity/glass: 705 ccm Design: 2017	Height/glass: 250 mm Capacity/glass: 705 ccm Design: 2017
PACKAGING	Pieces/Bill unit: 1	Pieces/Bill unit: 1	Pieces/Bill unit: 1	Pieces/Bill unit: 1
TYPE AND QUANTITY	Bill units/MP: 4	Bill units/MP: 4	Bill units/MP: 4	Bill units/MP: 4
BILL UNIT	Length: 146 mm	Length: 146 mm	Length: 146 mm	Length: 146 mm
DIMENSIONS	Width: 133 mm	Width: 133 mm	Width: 133 mm	Width: 133 mm
	Height: 327 mm	Height: 327 mm	Height: 327 mm	Height: 327 mm
	Weight: 373 gr	Weight: 373 gr	Weight: 373 gr	Weight: 373 gr
MASTERPACK	Length: 304 mm	Length: 304 mm	Length: 304 mm	Length: 304 mm
DIMENSIONS	Width: 286 mm	Width: 286 mm	Width: 286 mm	Width: 286 mm
	Height: 343 mm	Height: 343 mm	Height: 343 mm	Height: 343 mm
	Weight: 1752 gr	Weight: 1752 gr	Weight: 1752 gr	Weight: 1752 gr
EURO PALLET	Bill units/pallet: 96	Bill units/pallet: 96	Bill units/pallet: 96	Bill units/pallet: 96
	Bill units/layer: 32	Bill units/layer: 32	Bill units/layer: 32	Bill units/layer: 32
	Layers/pallet: 3	Layers/pallet: 3	Layers/pallet: 3	Layers/pallet: 3
CONTAINER PALLET	Bill units/pallet: 288	Bill units/pallet: 288	Bill units/pallet: 288	Bill units/pallet: 288
HIGH CUBE	Bill units/layer: 48	Bill units/layer: 48	Bill units/layer: 48	Bill units/layer: 48
	Layers/pallet: 6	Layers/pallet: 6	Layers/pallet: 6	Layers/pallet: 6
EAN				
BILL UNIT	9 006206 214662	9 006206 214679	9 006206 214686	9 006206 214693



Pinot Noir
Green







Pinot Noir
Black



Pinot Noir
Pink



Pinot Noir
Opal Violet

ITEM	Item no.:	4900/07G	Item no.:	4900/07B	Item no.:	4900/07P	Item no.:	4900/07V
	fine crystal handmade		fine crystal handmade		fine crystal handmade		fine crystal handmade	
	Height/glass:	250 mm	Height/glass:	250 mm	Height/glass:	250 mm	Height/glass:	250 mm
	Capacity/glass:	705 ccm	Capacity/glass:	705 ccm	Capacity/glass:	705 ccm	Capacity/glass:	705 ccm
	Design:	2017	Design:	2017	Design:	2018	Design:	2020
PACKAGING TYPE AND QUANTITY	Pieces/Bill unit:	1	Pieces/Bill unit:	1	Pieces/Bill unit:	1	Pieces/Bill unit:	1
	Bill units/MP:	4	Bill units/MP:	4	Bill units/MP:	4	Bill units/MP:	4
BILL UNIT DIMENSIONS	Length:	146 mm	Length:	146 mm	Length:	146 mm	Length:	146 mm
	Width:	133 mm	Width:	133 mm	Width:	133 mm	Width:	133 mm
	Height:	327 mm	Height:	327 mm	Height:	327 mm	Height:	327 mm
	Weight:	373 gr	Weight:	373 gr	Weight:	373 gr	Weight:	373 gr
MASTERPACK DIMENSIONS	Length:	304 mm	Length:	304 mm	Length:	304 mm	Length:	304 mm
	Width:	286 mm	Width:	286 mm	Width:	286 mm	Width:	286 mm
	Height:	343 mm	Height:	343 mm	Height:	343 mm	Height:	343 mm
	Weight:	1752 gr	Weight:	1752 gr	Weight:	1752 gr	Weight:	1752 gr
EURO PALLET	Bill units/pallet:	96	Bill units/pallet:	96	Bill units/pallet:	96	Bill units/pallet:	96
	Bill units/layer:	32	Bill units/layer:	32	Bill units/layer:	32	Bill units/layer:	32
	Layers/pallet:	3	Layers/pallet:	3	Layers/pallet:	3	Layers/pallet:	3
CONTAINER PALLET HIGH CUBE	Bill units/pallet:	288	Bill units/pallet:	288	Bill units/pallet:	288	Bill units/pallet:	288
	Bill units/layer:	48	Bill units/layer:	48	Bill units/layer:	48	Bill units/layer:	48
	Layers/pallet:	6	Layers/pallet:	6	Layers/pallet:	6	Layers/pallet:	6
EAN BILL UNIT	 9 006206 214709		 9 006206 214716		 9 006206 215249		 9 006206 215232	



Syrah
Mauve







Syrah
Mint



Syrah
Orange



Syrah
Turquoise

ITEM	Item no.: 4900/41MA	Item no.: 4900/41M	Item no.: 4900/41O	Item no.: 4900/41T
	fine crystal handmade	fine crystal handmade	fine crystal handmade	fine crystal handmade
	Height/glass: 250 mm Capacity/glass: 600 ccm Design: 2022	Height/glass: 250 mm Capacity/glass: 600 ccm Design: 2022	Height/glass: 250 mm Capacity/glass: 600 ccm Design: 2022	Height/glass: 250 mm Capacity/glass: 600 ccm Design: 2022
PACKAGING TYPE AND QUANTITY	Pieces/Bill unit: 1	Pieces/Bill unit: 1	Pieces/Bill unit: 1	Pieces/Bill unit: 1
	Bill units/MP: 4	Bill units/MP: 4	Bill units/MP: 4	Bill units/MP: 4
BILL UNIT DIMENSIONS	Length: 146 mm	Length: 146 mm	Length: 146 mm	Length: 146 mm
	Width: 133 mm	Width: 133 mm	Width: 133 mm	Width: 133 mm
	Height: 327 mm	Height: 327 mm	Height: 327 mm	Height: 327 mm
	Weight: 368 gr	Weight: 368 gr	Weight: 368 gr	Weight: 368 gr
MASTERPACK DIMENSIONS	Length: 304 mm	Length: 304 mm	Length: 304 mm	Length: 304 mm
	Width: 286 mm	Width: 286 mm	Width: 286 mm	Width: 286 mm
	Height: 343 mm	Height: 343 mm	Height: 343 mm	Height: 343 mm
	Weight: 1732 gr	Weight: 1732 gr	Weight: 1732 gr	Weight: 1732 gr
EURO PALLET	Bill units/pallet: 96	Bill units/pallet: 96	Bill units/pallet: 96	Bill units/pallet: 96
	Bill units/layer: 32	Bill units/layer: 32	Bill units/layer: 32	Bill units/layer: 32
	Layers/pallet: 3	Layers/pallet: 3	Layers/pallet: 3	Layers/pallet: 3
CONTAINER PALLET HIGH CUBE	Bill units/pallet: 288	Bill units/pallet: 288	Bill units/pallet: 288	Bill units/pallet: 288
	Bill units/layer: 48	Bill units/layer: 48	Bill units/layer: 48	Bill units/layer: 48
	Layers/pallet: 6	Layers/pallet: 6	Layers/pallet: 6	Layers/pallet: 6
EAN BILL UNIT	 9 006206 323524	 9 006206 323647	 9 006206 323463	 9 006206 323586





Syrah
White







Syrah
Yellow



Syrah
Red



Syrah
Dark Blue

ITEM	Item no.: 4900/41W fine crystal handmade	Item no.: 4900/41Y fine crystal handmade	Item no.: 4900/41R fine crystal handmade	Item no.: 4900/41D fine crystal handmade
	Height/glass: 250 mm Capacity/glass: 600 ccm Design: 2017	Height/glass: 250 mm Capacity/glass: 600 ccm Design: 2017	Height/glass: 250 mm Capacity/glass: 600 ccm Design: 2017	Height/glass: 250 mm Capacity/glass: 600 ccm Design: 2017
PACKAGING TYPE AND QUANTITY	Pieces/Bill unit: 1 Bill units/MP: 4	Pieces/Bill unit: 1 Bill units/MP: 4	Pieces/Bill unit: 1 Bill units/MP: 4	Pieces/Bill unit: 1 Bill units/MP: 4
BILL UNIT DIMENSIONS	Length: 146 mm Width: 133 mm Height: 327 mm Weight: 368 gr	Length: 146 mm Width: 133 mm Height: 327 mm Weight: 368 gr	Length: 146 mm Width: 133 mm Height: 327 mm Weight: 368 gr	Length: 146 mm Width: 133 mm Height: 327 mm Weight: 368 gr
MASTERPACK DIMENSIONS	Length: 304 mm Width: 286 mm Height: 343 mm Weight: 1732 gr	Length: 304 mm Width: 286 mm Height: 343 mm Weight: 1732 gr	Length: 304 mm Width: 286 mm Height: 343 mm Weight: 1732 gr	Length: 304 mm Width: 286 mm Height: 343 mm Weight: 1732 gr
EURO PALLET	Bill units/pallet: 96 Bill units/layer: 32 Layers/pallet: 3	Bill units/pallet: 96 Bill units/layer: 32 Layers/pallet: 3	Bill units/pallet: 96 Bill units/layer: 32 Layers/pallet: 3	Bill units/pallet: 96 Bill units/layer: 32 Layers/pallet: 3
CONTAINER PALLET HIGH CUBE	Bill units/pallet: 288 Bill units/layer: 48 Layers/pallet: 6	Bill units/pallet: 288 Bill units/layer: 48 Layers/pallet: 6	Bill units/pallet: 288 Bill units/layer: 48 Layers/pallet: 6	Bill units/pallet: 288 Bill units/layer: 48 Layers/pallet: 6
EAN BILL UNIT	 9 006206 214785	 9 006206 214792	 9 006206 214808	 9 006206 214815



Syrah
Green







Syrah
Black



Syrah
Pink



Syrah
Opal Violet

ITEM	Item no.: 4900/41G fine crystal handmade	Item no.: 4900/41B fine crystal handmade	Item no.: 4900/41P fine crystal handmade	Item no.: 4900/41V fine crystal handmade
	Height/glass: 250 mm Capacity/glass: 600 ccm Design: 2017	Height/glass: 250 mm Capacity/glass: 600 ccm Design: 2017	Height/glass: 250 mm Capacity/glass: 600 ccm Design: 2018	Height/glass: 250 mm Capacity/glass: 600 ccm Design: 2020
PACKAGING	Pieces/Bill unit: 1	Pieces/Bill unit: 1	Pieces/Bill unit: 1	Pieces/Bill unit: 1
TYPE AND QUANTITY	Bill units/MP: 4	Bill units/MP: 4	Bill units/MP: 4	Bill units/MP: 4
BILL UNIT	Length: 146 mm	Length: 146 mm	Length: 146 mm	Length: 290 mm
DIMENSIONS	Width: 133 mm	Width: 133 mm	Width: 133 mm	Width: 130 mm
	Height: 327 mm	Height: 327 mm	Height: 327 mm	Height: 130 mm
	Weight: 368 gr	Weight: 368 gr	Weight: 368 gr	Weight: 368 gr
MASTERPACK	Length: 304 mm	Length: 304 mm	Length: 304 mm	Length: 526 mm
DIMENSIONS	Width: 286 mm	Width: 286 mm	Width: 286 mm	Width: 144 mm
	Height: 343 mm	Height: 343 mm	Height: 343 mm	Height: 303 mm
	Weight: 1732 gr	Weight: 1732 gr	Weight: 1732 gr	Weight: 1732 gr
EURO PALLET	Bill units/pallet: 96	Bill units/pallet: 96	Bill units/pallet: 96	Bill units/pallet: 96
	Bill units/layer: 32	Bill units/layer: 32	Bill units/layer: 32	Bill units/layer: 32
	Layers/pallet: 3	Layers/pallet: 3	Layers/pallet: 3	Layers/pallet: 3
CONTAINER PALLET	Bill units/pallet: 288	Bill units/pallet: 288	Bill units/pallet: 288	Bill units/pallet: 288
HIGH CUBE	Bill units/layer: 48	Bill units/layer: 48	Bill units/layer: 48	Bill units/layer: 48
	Layers/pallet: 6	Layers/pallet: 6	Layers/pallet: 6	Layers/pallet: 6
EAN				
BILL UNIT	9 006206 214822	9 006206 214839	9 006206 215201	9 006206 215294



Champagne Wine Glass
Mauve



Champagne Wine Glass
Mint



Champagne Wine Glass
Orange



Champagne Wine Glass
Turquoise

ITEM	Item no.: 4900/28MA fine crystal handmade	Item no.: 4900/28M fine crystal handmade	Item no.: 4900/28O fine crystal handmade	Item no.: 4900/28T fine crystal handmade
	Height/glass: 250 mm Capacity/glass: 445 ccm Design: 2022	Height/glass: 250 mm Capacity/glass: 445 ccm Design: 2022	Height/glass: 250 mm Capacity/glass: 445 ccm Design: 2022	Height/glass: 250 mm Capacity/glass: 445 ccm Design: 2022
PACKAGING	Pieces/Bill unit: 1	Pieces/Bill unit: 1	Pieces/Bill unit: 1	Pieces/Bill unit: 1
TYPE AND QUANTITY	Bill units/MP: 4	Bill units/MP: 4	Bill units/MP: 4	Bill units/MP: 4
BILL UNIT	Length: 146 mm	Length: 146 mm	Length: 146 mm	Length: 146 mm
DIMENSIONS	Width: 133 mm	Width: 133 mm	Width: 133 mm	Width: 133 mm
	Height: 327 mm	Height: 327 mm	Height: 327 mm	Height: 327 mm
	Weight: 368 gr	Weight: 368 gr	Weight: 368 gr	Weight: 368 gr
MASTERPACK	Length: 304 mm	Length: 304 mm	Length: 304 mm	Length: 304 mm
DIMENSIONS	Width: 286 mm	Width: 286 mm	Width: 286 mm	Width: 286 mm
	Height: 343 mm	Height: 343 mm	Height: 343 mm	Height: 343 mm
	Weight: 1732 gr	Weight: 1732 gr	Weight: 1732 gr	Weight: 1732 gr
EURO PALLET	Bill units/pallet: 96	Bill units/pallet: 96	Bill units/pallet: 96	Bill units/pallet: 96
	Bill units/layer: 32	Bill units/layer: 32	Bill units/layer: 32	Bill units/layer: 32
	Layers/pallet: 3	Layers/pallet: 3	Layers/pallet: 3	Layers/pallet: 3
CONTAINER PALLET	Bill units/pallet: 288	Bill units/pallet: 288	Bill units/pallet: 288	Bill units/pallet: 288
HIGH CUBE	Bill units/layer: 48	Bill units/layer: 48	Bill units/layer: 48	Bill units/layer: 48
	Layers/pallet: 6	Layers/pallet: 6	Layers/pallet: 6	Layers/pallet: 6
EAN				
BILL UNIT				





Champagne Wine Glass
White







Champagne Wine Glass
Yellow



Champagne Wine Glass
Red



Champagne Wine Glass
Dark Blue

ITEM	Item no.: 4900/28W fine crystal handmade	Item no.: 4900/28Y fine crystal handmade	Item no.: 4900/28R fine crystal handmade	Item no.: 4900/28D fine crystal handmade
	Height/glass: 250 mm	Height/glass: 250 mm	Height/glass: 250 mm	Height/glass: 250 mm
	Capacity/glass: 445 ccm	Capacity/glass: 445 ccm	Capacity/glass: 445 ccm	Capacity/glass: 445 ccm
	Design: 2017	Design: 2017	Design: 2017	Design: 2017
PACKAGING	Pieces/Bill unit: 1	Pieces/Bill unit: 1	Pieces/Bill unit: 1	Pieces/Bill unit: 1
TYPE AND QUANTITY	Bill units/MP: 4	Bill units/MP: 4	Bill units/MP: 4	Bill units/MP: 4
BILL UNIT	Length: 146 mm	Length: 146 mm	Length: 146 mm	Length: 146 mm
DIMENSIONS	Width: 133 mm	Width: 133 mm	Width: 133 mm	Width: 133 mm
	Height: 327 mm	Height: 327 mm	Height: 327 mm	Height: 327 mm
	Weight: 368 gr	Weight: 368 gr	Weight: 368 gr	Weight: 368 gr
MASTERPACK	Length: 304 mm	Length: 304 mm	Length: 304 mm	Length: 304 mm
DIMENSIONS	Width: 286 mm	Width: 286 mm	Width: 286 mm	Width: 286 mm
	Height: 343 mm	Height: 343 mm	Height: 343 mm	Height: 343 mm
	Weight: 1732 gr	Weight: 1732 gr	Weight: 1732 gr	Weight: 1732 gr
EURO PALLET	Bill units/pallet: 96	Bill units/pallet: 96	Bill units/pallet: 96	Bill units/pallet: 96
	Bill units/layer: 32	Bill units/layer: 32	Bill units/layer: 32	Bill units/layer: 32
	Layers/pallet: 3	Layers/pallet: 3	Layers/pallet: 3	Layers/pallet: 3
CONTAINER PALLET	Bill units/pallet: 288	Bill units/pallet: 288	Bill units/pallet: 288	Bill units/pallet: 288
HIGH CUBE	Bill units/layer: 48	Bill units/layer: 48	Bill units/layer: 48	Bill units/layer: 48
	Layers/pallet: 6	Layers/pallet: 6	Layers/pallet: 6	Layers/pallet: 6
EAN				
BILL UNIT	9 006206 214969	9 006206 214976	9 006206 214983	9 006206 214990



Champagne Wine Glass
Green







Champagne Wine Glass
Black



Champagne Wine Glass
Pink



Champagne Wine Glass
Opal Violet

ITEM	Item no.: 4900/28G fine crystal handmade	Item no.: 4900/28B fine crystal handmade	Item no.: 4900/28P fine crystal handmade	Item no.: 4900/28V fine crystal handmade
	Height/glass: 250 mm Capacity/glass: 445 ccm Design: 2017	Height/glass: 250 mm Capacity/glass: 445 ccm Design: 2017	Height/glass: 250 mm Capacity/glass: 445 ccm Design: 2018	Height/glass: 250 mm Capacity/glass: 445 ccm Design: 2020
PACKAGING	Pieces/Bill unit: 1	Pieces/Bill unit: 1	Pieces/Bill unit: 1	Pieces/Bill unit: 1
TYPE AND QUANTITY	Bill units/MP: 4	Bill units/MP: 4	Bill units/MP: 4	Bill units/MP: 4
BILL UNIT	Length: 146 mm	Length: 146 mm	Length: 146 mm	Length: 146 mm
DIMENSIONS	Width: 133 mm	Width: 133 mm	Width: 133 mm	Width: 133 mm
	Height: 327 mm	Height: 327 mm	Height: 327 mm	Height: 327 mm
	Weight: 368 gr	Weight: 368 gr	Weight: 368 gr	Weight: 368 gr
MASTERPACK	Length: 304 mm	Length: 304 mm	Length: 304 mm	Length: 304 mm
DIMENSIONS	Width: 286 mm	Width: 286 mm	Width: 286 mm	Width: 286 mm
	Height: 343 mm	Height: 343 mm	Height: 343 mm	Height: 343 mm
	Weight: 1732 gr	Weight: 1732 gr	Weight: 1732 gr	Weight: 1732 gr
EURO PALLET	Bill units/pallet: 96	Bill units/pallet: 96	Bill units/pallet: 96	Bill units/pallet: 96
	Bill units/layer: 32	Bill units/layer: 32	Bill units/layer: 32	Bill units/layer: 32
	Layers/pallet: 3	Layers/pallet: 3	Layers/pallet: 3	Layers/pallet: 3
CONTAINER PALLET	Bill units/pallet: 288	Bill units/pallet: 288	Bill units/pallet: 288	Bill units/pallet: 288
HIGH CUBE	Bill units/layer: 48	Bill units/layer: 48	Bill units/layer: 48	Bill units/layer: 48
	Layers/pallet: 6	Layers/pallet: 6	Layers/pallet: 6	Layers/pallet: 6
EAN				
BILL UNIT	9 006206 215003	9 006206 215010	9 006206 215027	9 006206 215300



Riesling/Zinfandel
Mauve



Riesling/Zinfandel
Mint



Riesling/Zinfandel
Orange



Riesling/Zinfandel
Turquoise

ITEM	Item no.: 4900/15MA fine crystal handmade	Item no.: 4900/15M fine crystal handmade	Item no.: 4900/15O fine crystal handmade	Item no.: 4900/15T fine crystal handmade
	Height/glass: 250 mm	Height/glass: 250 mm	Height/glass: 250 mm	Height/glass: 250 mm
	Capacity/glass: 395 ccm	Capacity/glass: 395 ccm	Capacity/glass: 395 ccm	Capacity/glass: 395 ccm
	Design: 2022	Design: 2022	Design: 2022	Design: 2022
PACKAGING	Pieces/Bill unit: 1	Pieces/Bill unit: 1	Pieces/Bill unit: 1	Pieces/Bill unit: 1
TYPE AND QUANTITY	Bill units/MP: 4	Bill units/MP: 4	Bill units/MP: 4	Bill units/MP: 4
BILL UNIT	Length: 146 mm	Length: 146 mm	Length: 146 mm	Length: 146 mm
DIMENSIONS	Width: 133 mm	Width: 133 mm	Width: 133 mm	Width: 133 mm
	Height: 327 mm	Height: 327 mm	Height: 327 mm	Height: 327 mm
	Weight: 343 gr	Weight: 343 gr	Weight: 343 gr	Weight: 343 gr
MASTERPACK	Length: 304 mm	Length: 304 mm	Length: 304 mm	Length: 304 mm
DIMENSIONS	Width: 286 mm	Width: 286 mm	Width: 286 mm	Width: 286 mm
	Height: 343 mm	Height: 343 mm	Height: 343 mm	Height: 343 mm
	Weight: 1632 gr	Weight: 1632 gr	Weight: 1632 gr	Weight: 1632 gr
EURO PALLET	Bill units/pallet: 96	Bill units/pallet: 96	Bill units/pallet: 96	Bill units/pallet: 96
	Bill units/layer: 32	Bill units/layer: 32	Bill units/layer: 32	Bill units/layer: 32
	Layers/pallet: 3	Layers/pallet: 3	Layers/pallet: 3	Layers/pallet: 3
CONTAINER PALLET	Bill units/pallet: 288	Bill units/pallet: 288	Bill units/pallet: 288	Bill units/pallet: 288
HIGH CUBE	Bill units/layer: 48	Bill units/layer: 48	Bill units/layer: 48	Bill units/layer: 48
	Layers/pallet: 6	Layers/pallet: 6	Layers/pallet: 6	Layers/pallet: 6
EAN				
BILL UNIT	9 006206 323548	9 006206 323661	9 006206 322923	9 006206 323609





Riesling/Zinfandel
White







Riesling/Zinfandel
Yellow



Riesling/Zinfandel
Red



Riesling/Zinfandel
Dark Blue

ITEM	Item no.:	4900/15W	Item no.:	4900/15Y	Item no.:	4900/15R	Item no.:	4900/15D
	fine crystal handmade		fine crystal handmade		fine crystal handmade		fine crystal handmade	
	Height/glass:	250 mm	Height/glass:	250 mm	Height/glass:	250 mm	Height/glass:	250 mm
	Capacity/glass:	395 ccm	Capacity/glass:	395 ccm	Capacity/glass:	395 ccm	Capacity/glass:	395 ccm
	Design:	2017	Design:	2017	Design:	2017	Design:	2017
PACKAGING	Pieces/Bill unit:	1	Pieces/Bill unit:	1	Pieces/Bill unit:	1	Pieces/Bill unit:	1
TYPE AND QUANTITY	Bill units/MP:	4	Bill units/MP:	4	Bill units/MP:	4	Bill units/MP:	4
BILL UNIT	Length:	146 mm	Length:	146 mm	Length:	146 mm	Length:	146 mm
DIMENSIONS	Width:	133 mm	Width:	133 mm	Width:	133 mm	Width:	133 mm
	Height:	327 mm	Height:	327 mm	Height:	327 mm	Height:	327 mm
	Weight:	343 gr	Weight:	343 gr	Weight:	343 gr	Weight:	343 gr
MASTERPACK	Length:	304 mm	Length:	304 mm	Length:	304 mm	Length:	304 mm
DIMENSIONS	Width:	286 mm	Width:	286 mm	Width:	286 mm	Width:	286 mm
	Height:	343 mm	Height:	343 mm	Height:	343 mm	Height:	343 mm
	Weight:	1632 gr	Weight:	1632 gr	Weight:	1632 gr	Weight:	1632 gr
EURO PALLET	Bill units/pallet:	96	Bill units/pallet:	96	Bill units/pallet:	96	Bill units/pallet:	96
	Bill units/layer:	32	Bill units/layer:	32	Bill units/layer:	32	Bill units/layer:	32
	Layers/pallet:	3	Layers/pallet:	3	Layers/pallet:	3	Layers/pallet:	3
CONTAINER PALLET	Bill units/pallet:	288	Bill units/pallet:	288	Bill units/pallet:	288	Bill units/pallet:	288
HIGH CUBE	Bill units/layer:	48	Bill units/layer:	48	Bill units/layer:	48	Bill units/layer:	48
	Layers/pallet:	6	Layers/pallet:	6	Layers/pallet:	6	Layers/pallet:	6
EAN BILL UNIT	 9 006206 214846		 9 006206 214853		 9 006206 214860		 9 006206 214877	



Riesling/Zinfandel
Green



Riesling/Zinfandel
Black



Riesling/Zinfandel
Pink



Riesling/Zinfandel
Opal Violet

ITEM	Item no.: 4900/15G fine crystal handmade	Item no.: 4900/15B fine crystal handmade	Item no.: 4900/15P fine crystal handmade	Item no.: 4900/15V fine crystal handmade
	Height/glass: 250 mm	Height/glass: 250 mm	Height/glass: 250 mm	Height/glass: 250 mm
	Capacity/glass: 395 ccm	Capacity/glass: 395 ccm	Capacity/glass: 395 ccm	Capacity/glass: 395 ccm
	Design: 2017	Design: 2017	Design: 2018	Design: 2020
PACKAGING	Pieces/Bill unit: 1	Pieces/Bill unit: 1	Pieces/Bill unit: 1	Pieces/Bill unit: 1
TYPE AND QUANTITY	Bill units/MP: 4	Bill units/MP: 4	Bill units/MP: 4	Bill units/MP: 4
BILL UNIT	Length: 146 mm	Length: 146 mm	Length: 146 mm	Length: 290 mm
DIMENSIONS	Width: 133 mm	Width: 133 mm	Width: 133 mm	Width: 130 mm
	Height: 327 mm	Height: 327 mm	Height: 327 mm	Height: 130 mm
	Weight: 343 gr	Weight: 343 gr	Weight: 343 gr	Weight: 343 gr
MASTERPACK	Length: 304 mm	Length: 304 mm	Length: 304 mm	Length: 526 mm
DIMENSIONS	Width: 286 mm	Width: 286 mm	Width: 286 mm	Width: 144 mm
	Height: 343 mm	Height: 343 mm	Height: 343 mm	Height: 303 mm
	Weight: 1632 gr	Weight: 1632 gr	Weight: 1632 gr	Weight: 1632 gr
EURO PALLET	Bill units/pallet: 96	Bill units/pallet: 96	Bill units/pallet: 96	Bill units/pallet: 96
	Bill units/layer: 32	Bill units/layer: 32	Bill units/layer: 32	Bill units/layer: 32
	Layers/pallet: 3	Layers/pallet: 3	Layers/pallet: 3	Layers/pallet: 3
CONTAINER PALLET	Bill units/pallet: 288	Bill units/pallet: 288	Bill units/pallet: 288	Bill units/pallet: 288
HIGH CUBE	Bill units/layer: 48	Bill units/layer: 48	Bill units/layer: 48	Bill units/layer: 48
	Layers/pallet: 6	Layers/pallet: 6	Layers/pallet: 6	Layers/pallet: 6
EAN				
BILL UNIT	9 006206 214884	9 006206 214891	9 006206 215041	9 006206 215287



Oaked Chardonnay
Mauve







Oaked Chardonnay
Mint



Oaked Chardonnay
Orange



Oaked Chardonnay
Turquoise

ITEM	Item no.: 4900/97MA fine crystal handmade	Item no.: 4900/97M fine crystal handmade	Item no.: 4900/97O fine crystal handmade	Item no.: 4900/97T fine crystal handmade
	Height/glass: 250 mm	Height/glass: 250 mm	Height/glass: 250 mm	Height/glass: 250 mm
	Capacity/glass: 620 ccm	Capacity/glass: 620 ccm	Capacity/glass: 620 ccm	Capacity/glass: 620 ccm
	Design: 2022	Design: 2022	Design: 2022	Design: 2022
PACKAGING	Pieces/Bill unit: 1	Pieces/Bill unit: 1	Pieces/Bill unit: 1	Pieces/Bill unit: 1
TYPE AND QUANTITY	Bill units/MP: 4	Bill units/MP: 4	Bill units/MP: 4	Bill units/MP: 4
BILL UNIT	Length: 146 mm	Length: 146 mm	Length: 146 mm	Length: 146 mm
DIMENSIONS	Width: 133 mm	Width: 133 mm	Width: 133 mm	Width: 133 mm
	Height: 327 mm	Height: 327 mm	Height: 327 mm	Height: 327 mm
	Weight: 368 gr	Weight: 368 gr	Weight: 368 gr	Weight: 368 gr
MASTERPACK	Length: 304 mm	Length: 304 mm	Length: 304 mm	Length: 304 mm
DIMENSIONS	Width: 286 mm	Width: 286 mm	Width: 286 mm	Width: 286 mm
	Height: 343 mm	Height: 343 mm	Height: 343 mm	Height: 343 mm
	Weight: 1732 gr	Weight: 1732 gr	Weight: 1732 gr	Weight: 1732 gr
EURO PALLET	Bill units/pallet: 96	Bill units/pallet: 96	Bill units/pallet: 96	Bill units/pallet: 96
	Bill units/layer: 32	Bill units/layer: 32	Bill units/layer: 32	Bill units/layer: 32
	Layers/pallet: 3	Layers/pallet: 3	Layers/pallet: 3	Layers/pallet: 3
CONTAINER PALLET	Bill units/pallet: 288	Bill units/pallet: 288	Bill units/pallet: 288	Bill units/pallet: 288
HIGH CUBE	Bill units/layer: 48	Bill units/layer: 48	Bill units/layer: 48	Bill units/layer: 48
	Layers/pallet: 6	Layers/pallet: 6	Layers/pallet: 6	Layers/pallet: 6
EAN	 9 006206 323555	 9 006206 323678	 9 006206 215348	 9 006206 323616





Oaked Chardonnay
White



Oaked Chardonnay
Yellow



Oaked Chardonnay
Red



Oaked Chardonnay
Dark Blue

ITEM	Item no.: 4900/97W fine crystal handmade	Item no.: 4900/97Y fine crystal handmade	Item no.: 4900/97R fine crystal handmade	Item no.: 4900/97D fine crystal handmade
	Height/glass: 250 mm	Height/glass: 250 mm	Height/glass: 250 mm	Height/glass: 250 mm
	Capacity/glass: 620 ccm	Capacity/glass: 620 ccm	Capacity/glass: 620 ccm	Capacity/glass: 620 ccm
	Design: 2017	Design: 2017	Design: 2017	Design: 2017
PACKAGING	Pieces/Bill unit: 1	Pieces/Bill unit: 1	Pieces/Bill unit: 1	Pieces/Bill unit: 1
TYPE AND QUANTITY	Bill units/MP: 4	Bill units/MP: 4	Bill units/MP: 4	Bill units/MP: 4
BILL UNIT	Length: 146 mm	Length: 146 mm	Length: 146 mm	Length: 146 mm
DIMENSIONS	Width: 133 mm	Width: 133 mm	Width: 133 mm	Width: 133 mm
	Height: 327 mm	Height: 327 mm	Height: 327 mm	Height: 327 mm
	Weight: 368 gr	Weight: 368 gr	Weight: 368 gr	Weight: 368 gr
MASTERPACK	Length: 304 mm	Length: 304 mm	Length: 304 mm	Length: 304 mm
DIMENSIONS	Width: 286 mm	Width: 286 mm	Width: 286 mm	Width: 286 mm
	Height: 343 mm	Height: 343 mm	Height: 343 mm	Height: 343 mm
	Weight: 1732 gr	Weight: 1732 gr	Weight: 1732 gr	Weight: 1732 gr
EURO PALLET	Bill units/pallet: 96	Bill units/pallet: 96	Bill units/pallet: 96	Bill units/pallet: 96
	Bill units/layer: 32	Bill units/layer: 32	Bill units/layer: 32	Bill units/layer: 32
	Layers/pallet: 3	Layers/pallet: 3	Layers/pallet: 3	Layers/pallet: 3
CONTAINER PALLET	Bill units/pallet: 288	Bill units/pallet: 288	Bill units/pallet: 288	Bill units/pallet: 288
HIGH CUBE	Bill units/layer: 48	Bill units/layer: 48	Bill units/layer: 48	Bill units/layer: 48
	Layers/pallet: 6	Layers/pallet: 6	Layers/pallet: 6	Layers/pallet: 6
EAN				
BILL UNIT	9 006206 214907	9 006206 214914	9 006206 214921	9 006206 214938



Oaked Chardonnay
Green



Oaked Chardonnay
Black



Oaked Chardonnay
Pink



Oaked Chardonnay
Opal Violet



ITEM	Item no.: fine crystal handmade	4900/97G	Item no.: fine crystal handmade	4900/97B	Item no.: fine crystal handmade	4900/97P	Item no.: fine crystal handmade	4900/97V
	Height/glass:	250 mm	Height/glass:	250 mm	Height/glass:	250 mm	Height/glass:	250 mm
	Capacity/glass:	620 ccm	Capacity/glass:	620 ccm	Capacity/glass:	620 ccm	Capacity/glass:	620 ccm
	Design:	2017	Design:	2017	Design:	2018	Design:	2020
PACKAGING	Pieces/Bill unit:	1	Pieces/Bill unit:	1	Pieces/Bill unit:	1	Pieces/Bill unit:	1
TYPE AND QUANTITY	Bill units/MP:	4	Bill units/MP:	4	Bill units/MP:	4	Bill units/MP:	4
BILL UNIT	Length:	146 mm	Length:	146 mm	Length:	146 mm	Length:	290 mm
DIMENSIONS	Width:	133 mm	Width:	133 mm	Width:	133 mm	Width:	130 mm
	Height:	327 mm	Height:	327 mm	Height:	327 mm	Height:	130 mm
	Weight:	368 gr	Weight:	368 gr	Weight:	368 gr	Weight:	368 gr
MASTERPACK	Length:	304 mm	Length:	304 mm	Length:	304 mm	Length:	526 mm
DIMENSIONS	Width:	286 mm	Width:	286 mm	Width:	286 mm	Width:	144 mm
	Height:	343 mm	Height:	343 mm	Height:	343 mm	Height:	303 mm
	Weight:	1732 gr	Weight:	1732 gr	Weight:	1732 gr	Weight:	1732 gr
EURO PALLET	Bill units/pallet:	96	Bill units/pallet:	96	Bill units/pallet:	96	Bill units/pallet:	96
	Bill units/layer:	32	Bill units/layer:	32	Bill units/layer:	32	Bill units/layer:	32
	Layers/pallet:	3	Layers/pallet:	3	Layers/pallet:	3	Layers/pallet:	3
CONTAINER PALLET	Bill units/pallet:	288	Bill units/pallet:	288	Bill units/pallet:	288	Bill units/pallet:	288
HIGH CUBE	Bill units/layer:	48	Bill units/layer:	48	Bill units/layer:	48	Bill units/layer:	48
	Layers/pallet:	6	Layers/pallet:	6	Layers/pallet:	6	Layers/pallet:	6
EAN								
BILL UNIT	9 006206 214945		9 006206 214952		9 006206 215218		9 006206 320110	



Gift Set
Cabernet/Merlot



Gift Set
Champagne Glass

ITEM	Item no.: 7900/0-23 fine crystal handmade Height/glass: 250 mm Capacity/glass: 625 ccm Design: 2023	Item no.: 7900/28-23 fine crystal handmade Height/glass: 250 mm Capacity/glass: 445 ccm Design: 2023
PACKAGING TYPE AND QUANTITY	Pieces/Bill unit: 6 Bill units/MP: 2	Pieces/Bill unit: 6 Bill units/MP: 2
BILL UNIT DIMENSIONS	Length: 359 mm Width: 242 mm Height: 272 mm Weight: 1293 gr	Length: 359 mm Width: 242 mm Height: 272 mm Weight: 1263 gr
MASTERPACK DIMENSIONS	Length: 496 mm Width: 371 mm Height: 287 mm Weight: 3035 gr	Length: 496 mm Width: 371 mm Height: 287 mm Weight: 2975 gr
EURO PALLET	Bill units/pallet: 32 Bill units/layer: 8 Layers/pallet: 4	Bill units/pallet: 32 Bill units/layer: 8 Layers/pallet: 4
CONTAINER PALLET HIGH CUBE	Bill units/pallet: 96 Bill units/layer: 12 Layers/pallet: 8	Bill units/pallet: 96 Bill units/layer: 12 Layers/pallet: 8
EAN BILL UNIT	 9 006206 326457	 9 006206 326464





HANDMADE



**PREMIUM MACHINE-MADE
IN WEIDEN, GERMANY**

PREMIUM MACHINE-MADE - BLOWN IN WEIDEN, GERMANY

„PREMIUM“ defines the advantage of a machine blown RIEDEL glass vs. a handmade glass.

The difference lies within the precision.

Since RIEDEL glasses are fine-tuned instruments that support your wine enjoyment, we must make sure that there are no variances in the execution of the bowl and rim diameter, which is the key to our grape varietal specific philosophy!

RIEDEL LAUDON





RIEDEL LAUDON (2020)

Presented in stunning colors like precious gems, the RIEDEL Laudon Tumblers are truly eye-catching. The luxurious cut-crystal design reflects light to allow the tumblers to sparkle. Perfect for whisky, water, cocktails or mixed drinks, these glasses will add style to any table setting and can be purchased individually for a truly unique look.







Tumbler
Gold

Tumbler
Silver

Tumbler
Red

Tumbler
Dark Green

ITEM	Item no.: 1515/02S3AU fine crystal machine-made	Item no.: 1515/02S3AU fine crystal machine-made	Item no.: 1515/02S3R fine crystal machine-made	Item no.: 1515/02S3DG fine crystal machine-made
	Height/glass: 102 mm	Height/glass: 102 mm	Height/glass: 102 mm	Height/glass: 102 mm
	Capacity/glass: 295 ccm	Capacity/glass: 295 ccm	Capacity/glass: 295 ccm	Capacity/glass: 295 ccm
	Design: 2022	Design: 2022	Design: 2020	Design: 2020
PACKAGING	Pieces/Bill unit: 1	Pieces/Bill unit: 1	Pieces/Bill unit: 1	Pieces/Bill unit: 1
TYPE AND QUANTITY	Bill units/MP: 4	Bill units/MP: 4	Bill units/MP: 4	Bill units/MP: 4
BILL UNIT	Length: 86 mm	Length: 86 mm	Length: 86 mm	Length: 86 mm
DIMENSIONS	Width: 86 mm	Width: 86 mm	Width: 86 mm	Width: 86 mm
	Height: 110 mm	Height: 110 mm	Height: 110 mm	Height: 110 mm
	Weight: 445 gr	Weight: 445 gr	Weight: 445 gr	Weight: 445 gr
MASTERPACK	Length: 184 mm	Length: 184 mm	Length: 184 mm	Length: 184 mm
DIMENSIONS	Width: 184 mm	Width: 184 mm	Width: 184 mm	Width: 184 mm
	Height: 122 mm	Height: 122 mm	Height: 122 mm	Height: 122 mm
	Weight: 1854 gr	Weight: 1854 gr	Weight: 1854 gr	Weight: 1854 gr
EURO PALLET	Bill units/pallet: 864	Bill units/pallet: 864	Bill units/pallet: 864	Bill units/pallet: 864
	Bill units/layer: 96	Bill units/layer: 96	Bill units/layer: 96	Bill units/layer: 96
	Layers/pallet: 9	Layers/pallet: 9	Layers/pallet: 9	Layers/pallet: 9
CONTAINER PALLET	Bill units/pallet: 1200	Bill units/pallet: 1200	Bill units/pallet: 1200	Bill units/pallet: 1200
HIGH CUBE	Bill units/layer: 120	Bill units/layer: 120	Bill units/layer: 120	Bill units/layer: 120
	Layers/pallet: 10	Layers/pallet: 10	Layers/pallet: 10	Layers/pallet: 10
EAN				
BILL UNIT	9 006206 325184	9 006206 325177	9 006206 320127	9 006206 320967





Tumbler
Bronze



Tumbler
White







Tumbler
Dark Blue



Tumbler
Rosé

MACHINE-MADE

ITEM	Item no.: 1515/02S3BR fine crystal machine-made	Item no.: 1515/02S3W fine crystal machine-made	Item no.: 1515/02S3DB fine crystal machine-made	Item no.: 1515/02S3RO fine crystal machine-made
	Height/glass: 102 mm Capacity/glass: 295 ccm Design: 2022	Height/glass: 102 mm Capacity/glass: 295 ccm Design: 2022	Height/glass: 102 mm Capacity/glass: 295 ccm Design: 2022	Height/glass: 102 mm Capacity/glass: 295 ccm Design: 2022
PACKAGING	Pieces/Bill unit: 1	Pieces/Bill unit: 1	Pieces/Bill unit: 1	Pieces/Bill unit: 1
TYPE AND QUANTITY	Bill units/MP: 4	Bill units/MP: 4	Bill units/MP: 4	Bill units/MP: 4
BILL UNIT	Length: 86 mm	Length: 86 mm	Length: 86 mm	Length: 86 mm
DIMENSIONS	Width: 86 mm	Width: 86 mm	Width: 86 mm	Width: 86 mm
	Height: 110 mm	Height: 110 mm	Height: 110 mm	Height: 110 mm
	Weight: 445 gr	Weight: 445 gr	Weight: 445 gr	Weight: 445 gr
MASTERPACK	Length: 184 mm	Length: 184 mm	Length: 184 mm	Length: 184 mm
DIMENSIONS	Width: 184 mm	Width: 184 mm	Width: 184 mm	Width: 184 mm
	Height: 122 mm	Height: 122 mm	Height: 122 mm	Height: 122 mm
	Weight: 1854 gr	Weight: 1854 gr	Weight: 1854 gr	Weight: 1854 gr
EURO PALLET	Bill units/pallet: 864	Bill units/pallet: 864	Bill units/pallet: 864	Bill units/pallet: 864
	Bill units/layer: 96	Bill units/layer: 96	Bill units/layer: 96	Bill units/layer: 96
	Layers/pallet: 9	Layers/pallet: 9	Layers/pallet: 9	Layers/pallet: 9
CONTAINER PALLET	Bill units/pallet: 1200	Bill units/pallet: 1200	Bill units/pallet: 1200	Bill units/pallet: 1200
HIGH CUBE	Bill units/layer: 120	Bill units/layer: 120	Bill units/layer: 120	Bill units/layer: 120
	Layers/pallet: 10	Layers/pallet: 10	Layers/pallet: 10	Layers/pallet: 10
EAN				
BILL UNIT	9 006206 322954	9 006206 322930	9 006206 322947	9 006206 322961



Tumbler
Turquoise



Tumbler
Violet



Tumbler
Light Green



Tumbler
Black

ITEM	Item no.: 1515/02S3T fine crystal machine-made	Item no.: 1515/02S3V fine crystal machine-made	Item no.: 1515/02S3G fine crystal machine-made	Item no.: 1515/02S3B fine crystal machine-made
	Height/glass: 102 mm Capacity/glass: 295 ccm Design: 2021	Height/glass: 102 mm Capacity/glass: 295 ccm Design: 2021	Height/glass: 102 mm Capacity/glass: 295 ccm Design: 2020	Height/glass: 102 mm Capacity/glass: 295 ccm Design: 2020
PACKAGING TYPE AND QUANTITY	Pieces/Bill unit: 1 Bill units/MP: 4	Pieces/Bill unit: 1 Bill units/MP: 4	Pieces/Bill unit: 1 Bill units/MP: 4	Pieces/Bill unit: 1 Bill units/MP: 4
BILL UNIT DIMENSIONS	Length: 86 mm Width: 86 mm Height: 110 mm Weight: 445 gr	Length: 86 mm Width: 86 mm Height: 110 mm Weight: 445 gr	Length: 86 mm Width: 86 mm Height: 110 mm Weight: 445 gr	Length: 86 mm Width: 86 mm Height: 110 mm Weight: 445 gr
MASTERPACK DIMENSIONS	Length: 184 mm Width: 184 mm Height: 122 mm Weight: 1854 gr	Length: 184 mm Width: 184 mm Height: 122 mm Weight: 1854 gr	Length: 184 mm Width: 184 mm Height: 122 mm Weight: 1854 gr	Length: 184 mm Width: 184 mm Height: 122 mm Weight: 1854 gr
EURO PALLET	Bill units/pallet: 864 Bill units/layer: 96 Layers/pallet: 9	Bill units/pallet: 864 Bill units/layer: 96 Layers/pallet: 9	Bill units/pallet: 864 Bill units/layer: 96 Layers/pallet: 9	Bill units/pallet: 864 Bill units/layer: 96 Layers/pallet: 9
CONTAINER PALLET HIGH CUBE	Bill units/pallet: 1200 Bill units/layer: 120 Layers/pallet: 10	Bill units/pallet: 1200 Bill units/layer: 120 Layers/pallet: 10	Bill units/pallet: 1200 Bill units/layer: 120 Layers/pallet: 10	Bill units/pallet: 1200 Bill units/layer: 120 Layers/pallet: 10
EAN BILL UNIT				







Tumbler
Pink



Tumbler
Amber



Tumbler
Light Blue

ITEM	Item no.: 1515/02S3P fine crystal machine-made	Item no.: 1515/02S3A fine crystal machine-made	Item no.: 1515/02S3LB fine crystal machine-made
	Height/glass: 102 mm Capacity/glass: 295 ccm Design: 2020	Height/glass: 102 mm Capacity/glass: 295 ccm Design: 2021	Height/glass: 102 mm Capacity/glass: 295 ccm Design: 2020
PACKAGING	Pieces/Bill unit: 1	Pieces/Bill unit: 1	Pieces/Bill unit: 1
TYPE AND QUANTITY	Bill units/MP: 4	Bill units/MP: 4	Bill units/MP: 4
BILL UNIT	Length: 86 mm	Length: 86 mm	Length: 86 mm
DIMENSIONS	Width: 86 mm	Width: 86 mm	Width: 86 mm
	Height: 110 mm	Height: 110 mm	Height: 110 mm
	Weight: 445 gr	Weight: 445 gr	Weight: 445 gr
MASTERPACK	Length: 184 mm	Length: 184 mm	Length: 184 mm
DIMENSIONS	Width: 184 mm	Width: 184 mm	Width: 184 mm
	Height: 122 mm	Height: 122 mm	Height: 122 mm
	Weight: 1854 gr	Weight: 1854 gr	Weight: 1854 gr
EURO PALLET	Bill units/pallet: 864	Bill units/pallet: 864	Bill units/pallet: 864
	Bill units/layer: 96	Bill units/layer: 96	Bill units/layer: 96
	Layers/pallet: 9	Layers/pallet: 9	Layers/pallet: 9
CONTAINER PALLET	Bill units/pallet: 1200	Bill units/pallet: 1200	Bill units/pallet: 1200
HIGH CUBE	Bill units/layer: 120	Bill units/layer: 120	Bill units/layer: 120
	Layers/pallet: 10	Layers/pallet: 10	Layers/pallet: 10
EAN BILL UNIT	 9 006206 320943	 9 006206 322022	 9 006206 320608

RIEDEL SUPERLEGGERO



RIEDEL SUPERLEGGERO (2023)

In homage to the 50th Anniversary of Sommeliers, RIEDEL relaunches RIEDEL Superleggero, and sets a new benchmark for premium machine-blown wine glasses.

RIEDEL Superleggero is a masterpiece of state-of-the-art-technology. The perfection of a machine-made glass compared to handmade lies in the precision of the bowl and rim diameter and its consistent quality. The collection includes the largest, thinnest, and lightest glasses with the widest base diameter ever produced on machine. RIEDEL Superleggero glasses are fine-tuned instruments, specifically shaped to enhance your wine enjoyment. Perfectly balanced, grape varietal specific and with the look and feel of a handmade glass. The collection features eight grape varietal shapes.

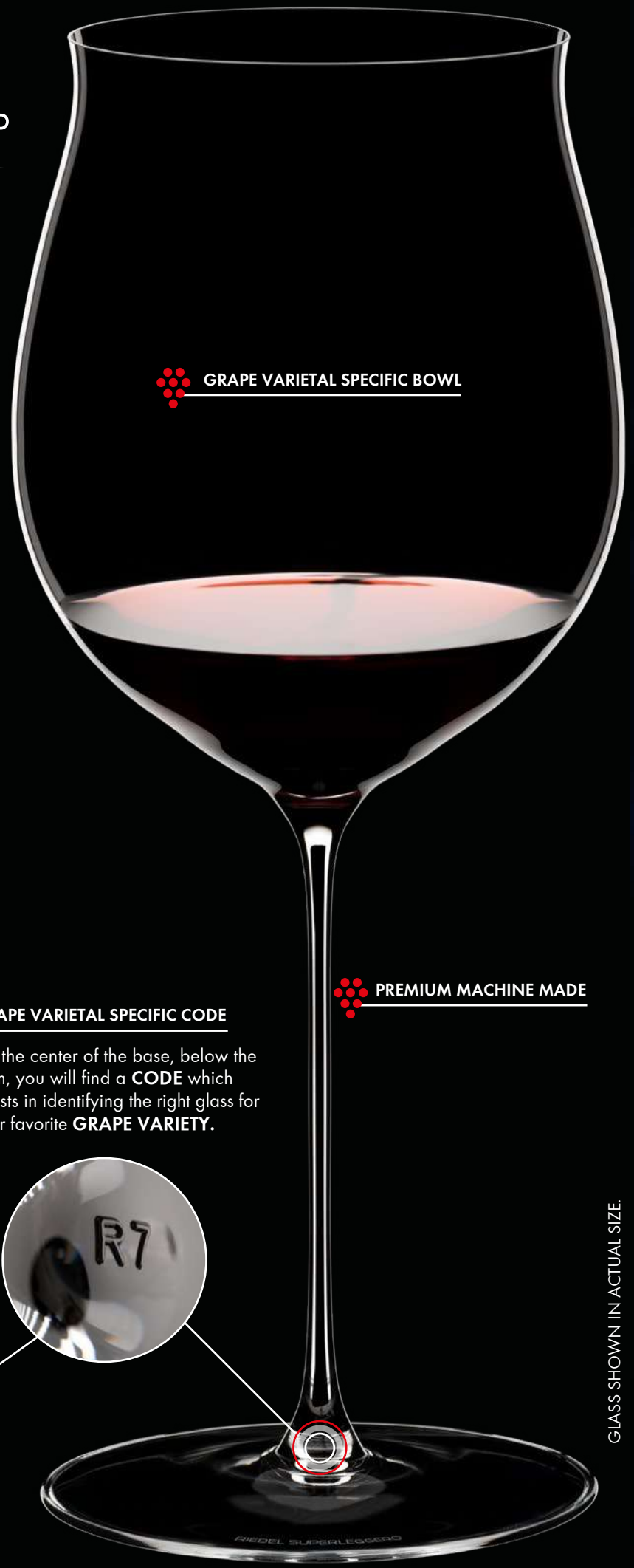

 **GRAPE VARIETAL SPECIFIC BOWL**

 **PREMIUM MACHINE MADE**

GRAPE VARIETAL SPECIFIC CODE

On the center of the base, below the stem, you will find a **CODE** which assists in identifying the right glass for your favorite **GRAPE VARIETY**.



GRAPE VARIETAL SPECIFIC CODE

	Riesling	R1
	Chardonnay	R2
	Sauvignon Blanc	R3
	Champagne Wine Glass	R4
	Spiritis	R5
	Hermitage/Syrah	R6
	Burgundy Grand Cru	R7
	Bordeaux Grand Cru	R8

GLASS SHOWN IN ACTUAL SIZE.

 **LARGEST BASE EVER PRODUCED ON MACHINE**



RIEDEL SUPERLEGGERO

MACHINE-MADE



Bordeaux Grand Cru



Burgundy Grand Cru



Hermitage / Syrah



Champagne Wine Glass

ITEM	Item no.: 6425/00 fine crystal premium machine-made	Item no.: 6425/16 fine crystal premium machine-made	Item no.: 6425/41 fine crystal premium machine-made	Item no.: 6425/28 fine crystal premium machine-made
	Height/glass: 282 mm	Height/glass: 276 mm	Height/glass: 267 mm	Height/glass: 260 mm
	Capacity/glass: 953 ccm	Capacity/glass: 1022 ccm	Capacity/glass: 668 ccm	Capacity/glass: 464 ccm
	Design: 2023	Design: 2023	Design: 2023	Design: 2023
PACKAGING	Pieces/Bill unit: 1	Pieces/Bill unit: 1	Pieces/Bill unit: 1	Pieces/Bill unit: 1
TYPE AND QUANTITY	Bill units/MP: 4	Bill units/MP: 4	Bill units/MP: 4	Bill units/MP: 4
BILL UNIT	Length: 329 mm	Length: 329 mm	Length: 329 mm	Length: 329 mm
DIMENSIONS	Width: 138 mm	Width: 138 mm	Width: 138 mm	Width: 138 mm
	Height: 132 mm	Height: 132 mm	Height: 132 mm	Height: 132 mm
	Weight: 336 gr	Weight: 339 gr	Weight: 317 gr	Weight: 296 gr
MASTERPACK	Length: 282 mm	Length: 282 mm	Length: 282 mm	Length: 282 mm
DIMENSIONS	Width: 272 mm	Width: 272 mm	Width: 272 mm	Width: 272 mm
	Height: 340 mm	Height: 340 mm	Height: 340 mm	Height: 340 mm
	Weight: 1584 gr	Weight: 1596 gr	Weight: 1508 gr	Weight: 1424 gr
EURO PALLET	Bill units/pallet: 160	Bill units/pallet: 160	Bill units/pallet: 160	Bill units/pallet: 160
	Bill units/layer: 32	Bill units/layer: 32	Bill units/layer: 32	Bill units/layer: 32
	Layers/pallet: 5	Layers/pallet: 5	Layers/pallet: 5	Layers/pallet: 5
CONTAINER PALLET	Bill units/pallet: 288	Bill units/pallet: 288	Bill units/pallet: 288	Bill units/pallet: 288
HIGH CUBE	Bill units/layer: 48	Bill units/layer: 48	Bill units/layer: 48	Bill units/layer: 48
	Layers/pallet: 6	Layers/pallet: 6	Layers/pallet: 6	Layers/pallet: 6
EAN				
BILL UNIT	9 006206 326020	9 006206 326082	9 006206 326075	9 006206 326068





Sauvignon Blanc



Riesling







Chardonnay



Spirits

MACHINE-MADE

ITEM	Item no.: 6425/33 fine crystal premium machine-made	Item no.: 6425/15 fine crystal premium machine-made	Item no.: 6425/97 fine crystal premium machine-made	Item no.: 6425/10 fine crystal premium machine-made
	Height/glass: 261 mm Capacity/glass: 400 ccm Design: 2023	Height/glass: 252 mm Capacity/glass: 400 ccm Design: 2023	Height/glass: 234 mm Capacity/glass: 660 ccm Design: 2023	Height/glass: 244 mm Capacity/glass: 248 ccm Design: 2023
PACKAGING	Pieces/Bill unit: 1	Pieces/Bill unit: 1	Pieces/Bill unit: 1	Pieces/Bill unit: 1
TYPE AND QUANTITY	Bill units/MP: 4	Bill units/MP: 4	Bill units/MP: 4	Bill units/MP: 4
BILL UNIT	Length: 329 mm	Length: 329 mm	Length: 329 mm	Length: 329 mm
DIMENSIONS	Width: 138 mm	Width: 138 mm	Width: 138 mm	Width: 138 mm
	Height: 132 mm	Height: 132 mm	Height: 132 mm	Height: 132 mm
	Weight: 299 gr	Weight: 292 gr	Weight: 308 gr	Weight: 281 gr
MASTERPACK	Length: 282 mm	Length: 282 mm	Length: 282 mm	Length: 282 mm
DIMENSIONS	Width: 272 mm	Width: 272 mm	Width: 272 mm	Width: 272 mm
	Height: 340 mm	Height: 340 mm	Height: 340 mm	Height: 340 mm
	Weight: 1436 gr	Weight: 1408 gr	Weight: 1472 gr	Weight: 1364 gr
EURO PALLET	Bill units/pallet: 160	Bill units/pallet: 160	Bill units/pallet: 160	Bill units/pallet: 160
	Bill units/layer: 32	Bill units/layer: 32	Bill units/layer: 32	Bill units/layer: 32
	Layers/pallet: 5	Layers/pallet: 5	Layers/pallet: 5	Layers/pallet: 5
CONTAINER PALLET	Bill units/pallet: 288	Bill units/pallet: 288	Bill units/pallet: 288	Bill units/pallet: 288
HIGH CUBE	Bill units/layer: 48	Bill units/layer: 48	Bill units/layer: 48	Bill units/layer: 48
	Layers/pallet: 6	Layers/pallet: 6	Layers/pallet: 6	Layers/pallet: 6
EAN				
BILL UNIT	9 006206 326051	9 006206 326013	9 006206 326044	9 006206 326037





RIEDEL WINE WINGS



MACHINE-MADE

RIEDEL WINEWINGS (2020) STRIKING COLLECTION BY GEORG RIEDEL

A flat-bottomed glass, wide and reminiscent of the wing of an aircraft, complete with winglets. Over the course of a year, through many tastings and by making changes to shape, size and rim diameter, what began as one glass for one grape varietal developed into seven different glasses to represent the most popular grape varietals. RIEDEL WINEWINGS was born and was about to take flight!



Cabernet/Merlot



Pinot Noir/Nebbiolo



Syrah



Champagne Wine Glass

ITEM	Item no.: 1234/0 fine crystal premium machine-made	Item no.: 1234/07 fine crystal premium machine-made	Item no.: 1234/41 fine crystal premium machine-made	Item no.: 1234/28 fine crystal premium machine-made
	Height/glass: 250 mm Capacity/glass: 1002 ccm Design: 2020	Height/glass: 250 mm Capacity/glass: 950 ccm Design: 2020	Height/glass: 250 mm Capacity/glass: 865 ccm Design: 2020	Height/glass: 250 mm Capacity/glass: 742 ccm Design: 2020
PACKAGING TYPE AND QUANTITY	Pieces/Bill unit: 1 Bill units/MP: 4	Pieces/Bill unit: 1 Bill units/MP: 4	Pieces/Bill unit: 1 Bill units/MP: 4	Pieces/Bill unit: 1 Bill units/MP: 4
BILL UNIT DIMENSIONS	Length: 146 mm Width: 133 mm Height: 327 mm Weight: 400 gr	Length: 146 mm Width: 133 mm Height: 327 mm Weight: 404 gr	Length: 146 mm Width: 133 mm Height: 327 mm Weight: 407 gr	Length: 146 mm Width: 133 mm Height: 327 mm Weight: 395 gr
MASTERPACK DIMENSIONS	Length: 304 mm Width: 286 mm Height: 343 mm Weight: 1860 gr	Length: 304 mm Width: 286 mm Height: 343 mm Weight: 1876 gr	Length: 304 mm Width: 286 mm Height: 343 mm Weight: 1888 gr	Length: 304 mm Width: 286 mm Height: 343 mm Weight: 1580 gr
EURO PALLET	Bill units/pallet: 160 Bill units/layer: 32 Layers/pallet: 5	Bill units/pallet: 160 Bill units/layer: 32 Layers/pallet: 5	Bill units/pallet: 160 Bill units/layer: 32 Layers/pallet: 5	Bill units/pallet: 160 Bill units/layer: 32 Layers/pallet: 5
CONTAINER PALLET HIGH CUBE	Bill units/pallet: 288 Bill units/layer: 48 Layers/pallet: 6	Bill units/pallet: 288 Bill units/layer: 48 Layers/pallet: 6	Bill units/pallet: 288 Bill units/layer: 48 Layers/pallet: 6	Bill units/pallet: 288 Bill units/layer: 48 Layers/pallet: 6
EAN BILL UNIT				







Riesling



Sauvignon Blanc



Chardonnay

ITEM	Item no.: 1234/15 fine crystal premium machine-made Height/glass: 250 mm Capacity/glass: 1017 ccm Design: 2020	Item no.: 1234/33 fine crystal premium machine-made Height/glass: 250 mm Capacity/glass: 742 ccm Design: 2020	Item no.: 1234/97 fine crystal premium machine-made Height/glass: 250 mm Capacity/glass: 736 ccm Design: 2020
PACKAGING TYPE AND QUANTITY	Pieces/Bill unit: 1 Bill units/MP: 4	Pieces/Bill unit: 1 Bill units/MP: 4	Pieces/Bill unit: 1 Bill units/MP: 4
BILL UNIT DIMENSIONS	Length: 146 mm Width: 133 mm Height: 327 mm Weight: 403 gr	Length: 146 mm Width: 133 mm Height: 327 mm Weight: 395 gr	Length: 146 mm Width: 133 mm Height: 327 mm Weight: 393 gr
MASTERPACK DIMENSIONS	Length: 304 mm Width: 286 mm Height: 343 mm Weight: 1872 gr	Length: 304 mm Width: 286 mm Height: 343 mm Weight: 1580 gr	Length: 304 mm Width: 286 mm Height: 343 mm Weight: 1832 gr
EURO PALLET	Bill units/pallet: 160 Bill units/layer: 32 Layers/pallet: 5	Bill units/pallet: 160 Bill units/layer: 32 Layers/pallet: 5	Bill units/pallet: 160 Bill units/layer: 32 Layers/pallet: 5
CONTAINER PALLET HIGH CUBE	Bill units/pallet: 288 Bill units/layer: 48 Layers/pallet: 6	Bill units/pallet: 288 Bill units/layer: 48 Layers/pallet: 6	Bill units/pallet: 288 Bill units/layer: 48 Layers/pallet: 6
EAN BILL UNIT	 9 006206 531134	 9 006206 531158	 9 006206 531165





Tasting Set

Cabernet/Merlot + Pinot Noir/Nebbiolo + Sauvignon Blanc + Chardonnay

ITEM	Item no.:	5123/47
	fine crystal	
	premium machine-made	
	Height/glass:	250 mm
	Capacity/glass:	-
	Design:	2020
PACKAGING	Pieces/Bill unit:	4
TYPE AND QUANTITY	Bill units/MP:	2
BILL UNIT	Length:	577 mm
DIMENSIONS	Width:	127 mm
	Height:	286 mm
	Weight:	1315 gr
MASTERPACK	Length:	587 mm
DIMENSIONS	Width:	271 mm
	Height:	297 mm
	Weight:	2988 gr
EURO PALLET	Bill units/pallet:	48
	Bill units/layer:	8
	Layers/pallet:	6
CONTAINER PALLET	Bill units/pallet:	84
HIGH CUBE	Bill units/layer:	12
	Layers/pallet:	7
EAN		
BILL UNIT		





MACHINE-MADE

RV

RIEDEL VELOCE





RIEDEL VELOCE (2022)

- MODERN GLASS THAT IMPRESSES THROUGH ITS BALANCE AND HAPTICS
- MODERATE PRICE AND DISHWASHER SAFE

RIEDEL VELOCE is an impressive development based on state-of-the-art technology. The glass is taller than the EXTREME and has a thinner stem and finer bowls. A specially developed machine, at RIEDEL's Weiden factory, enables us to draw stems that are the equal of those made by hand by a master glassmaker.



Cabernet/Merlot



Pinot Noir/Nebbiolo



Syrah/Shiraz



Champagne Wine Glass

ITEM	Item no.: 6330/0 fine crystal premium machine-made	Item no.: 6330/07 fine crystal premium machine-made	Item no.: 6330/41 fine crystal premium machine-made	Item no.: 6330/28 fine crystal premium machine-made
	Height/glass: 247 mm	Height/glass: 247 mm	Height/glass: 247 mm	Height/glass: 247 mm
	Capacity/glass: 829 ccm	Capacity/glass: 763 ccm	Capacity/glass: 720 ccm	Capacity/glass: 327 ccm
	Design: 2022	Design: 2022	Design: 2022	Design: 2022
PACKAGING	Pieces/Bill unit: 2	Pieces/Bill unit: 2	Pieces/Bill unit: 2	Pieces/Bill unit: 2
TYPE AND QUANTITY	Bill units/MP: 4	Bill units/MP: 4	Bill units/MP: 4	Bill units/MP: 4
BILL UNIT	Length: 289 mm	Length: 289 mm	Length: 289 mm	Length: 289 mm
DIMENSIONS	Width: 128 mm	Width: 128 mm	Width: 128 mm	Width: 128 mm
	Height: 283 mm	Height: 283 mm	Height: 283 mm	Height: 283 mm
	Weight: 611 gr	Weight: 631 gr	Weight: 595 gr	Weight: 559 gr
MASTERPACK	Length: 529 mm	Length: 529 mm	Length: 529 mm	Length: 529 mm
DIMENSIONS	Width: 299 mm	Width: 299 mm	Width: 299 mm	Width: 299 mm
	Height: 298 mm	Height: 298 mm	Height: 298 mm	Height: 298 mm
	Weight: 2789 gr	Weight: 2869 gr	Weight: 2725 gr	Weight: 2581 gr
EURO PALLET	Bill units/pallet: 96	Bill units/pallet: 96	Bill units/pallet: 96	Bill units/pallet: 96
	Bill units/layer: 16	Bill units/layer: 16	Bill units/layer: 16	Bill units/layer: 16
	Layers/pallet: 6	Layers/pallet: 6	Layers/pallet: 6	Layers/pallet: 6
CONTAINER PALLET	Bill units/pallet: 224	Bill units/pallet: 224	Bill units/pallet: 224	Bill units/pallet: 224
HIGH CUBE	Bill units/layer: 32	Bill units/layer: 32	Bill units/layer: 32	Bill units/layer: 32
	Layers/pallet: 7	Layers/pallet: 7	Layers/pallet: 7	Layers/pallet: 7
EAN				
BILL UNIT				





Sauvignon Blanc



Riesling







Chardonnay



Rosé

MACHINE-MADE

ITEM	Item no.: 6330/33 fine crystal premium machine-made	Item no.: 6330/15 fine crystal premium machine-made	Item no.: 6330/97 fine crystal premium machine-made	Item no.: 6330/55 fine crystal premium machine-made
	Height/glass: 247 mm Capacity/glass: 347 ccm Design: 2022	Height/glass: 247 mm Capacity/glass: 570 ccm Design: 2022	Height/glass: 247 mm Capacity/glass: 690 ccm Design: 2022	Height/glass: 247 mm Capacity/glass: 347 ccm Design: 2022
PACKAGING	Pieces/Bill unit: 2	Pieces/Bill unit: 2	Pieces/Bill unit: 2	Pieces/Bill unit: 2
TYPE AND QUANTITY	Bill units/MP: 4	Bill units/MP: 4	Bill units/MP: 4	Bill units/MP: 4
BILL UNIT	Length: 289 mm	Length: 289 mm	Length: 289 mm	Length: 289 mm
DIMENSIONS	Width: 128 mm	Width: 128 mm	Width: 128 mm	Width: 128 mm
	Height: 283 mm	Height: 283 mm	Height: 283 mm	Height: 283 mm
	Weight: 571 gr	Weight: 591 gr	Weight: 631 gr	Weight: 571 gr
MASTERPACK	Length: 529 mm	Length: 529 mm	Length: 529 mm	Length: 529 mm
DIMENSIONS	Width: 299 mm	Width: 299 mm	Width: 299 mm	Width: 299 mm
	Height: 298 mm	Height: 298 mm	Height: 298 mm	Height: 298 mm
	Weight: 2629 gr	Weight: 2709 gr	Weight: 2869 gr	Weight: 2629 gr
EURO PALLET	Bill units/pallet: 96	Bill units/pallet: 96	Bill units/pallet: 96	Bill units/pallet: 96
	Bill units/layer: 16	Bill units/layer: 16	Bill units/layer: 16	Bill units/layer: 16
	Layers/pallet: 6	Layers/pallet: 6	Layers/pallet: 6	Layers/pallet: 6
CONTAINER PALLET	Bill units/pallet: 224	Bill units/pallet: 224	Bill units/pallet: 224	Bill units/pallet: 224
HIGH CUBE	Bill units/layer: 32	Bill units/layer: 32	Bill units/layer: 32	Bill units/layer: 32
	Layers/pallet: 7	Layers/pallet: 7	Layers/pallet: 7	Layers/pallet: 7
EAN				
BILL UNIT	9 006206 324200	9 006206 324149	9 006206 324156	9 006206 324194





Water



Tasting Set

Cabernet/Merlot + Pinot Noir/Nebbiolo + Sauvignon Blanc + Chardonnay

ITEM	Item no.: 6330/02 fine crystal premium machine-made Height/glass: 100 mm Capacity/glass: 430 ccm Design: 2022	Item no.: 5330/47 fine crystal premium machine-made Height/glass: 247 mm Capacity/glass: - Design: 2022
PACKAGING TYPE AND QUANTITY	Pieces/Bill unit: 2 Bill units/MP: 4	Pieces/Bill unit: 4 Bill units/MP: 2
BILL UNIT DIMENSIONS	Length: 176 mm Width: 89 mm Height: 112 mm Weight: 303 gr	Length: 577 mm Width: 127 mm Height: 286 mm Weight: 1454 gr
MASTERPACK DIMENSIONS	Length: 418 mm Width: 233 mm Height: 157 mm Weight: 1528 gr	Length: 587 mm Width: 271 mm Height: 297 mm Weight: 3244 gr
EURO PALLET	Bill units/pallet: 252 Bill units/layer: 28 Layers/pallet: 9	Bill units/pallet: 48 Bill units/layer: 8 Layers/pallet: 6
CONTAINER PALLET HIGH CUBE	Bill units/pallet: 672 Bill units/layer: 48 Layers/pallet: 14	Bill units/pallet: 84 Bill units/layer: 12 Layers/pallet: 7
EAN BILL UNIT	 9 006206 324217	 9 006206 324231





Tasting Set

Cabernet/Merlot + Pinot Noir/Nebbiolo + Riesling + Chardonnay

ITEM	<p>Item no.: 5330/47-1</p> <p>fine crystal</p> <p>premium machine-made</p> <p>Height/glass: 247 mm</p> <p>Capacity/glass: -</p> <p>Design: 2022</p>
PACKAGING	<p>Pieces/Bill unit: 4</p>
TYPE AND QUANTITY	<p>Bill units/MP: 2</p>
BILL UNIT	<p>Length: 577 mm</p>
DIMENSIONS	<p>Width: 127 mm</p> <p>Height: 286 mm</p> <p>Weight: 1444 gr</p>
MASTERPACK	<p>Length: 587 mm</p>
DIMENSIONS	<p>Width: 271 mm</p> <p>Height: 297 mm</p> <p>Weight: 3224 gr</p>
EURO PALLET	<p>Bill units/pallet: 48</p> <p>Bill units/layer: 8</p> <p>Layers/pallet: 6</p>
CONTAINER PALLET	<p>Bill units/pallet: 84</p>
HIGH CUBE	<p>Bill units/layer: 12</p> <p>Layers/pallet: 7</p>
EAN	
BILL UNIT	 <p>9 006206 325344</p>



RIEDEL VERITAS

GRAPE  VARIETAL SPECIFIC®

RIEDEL VERITAS (2014) SPECTACULAR LIGHT AND GRACEFUL

Timeless and elegant RIEDEL VERITAS is fine blown and light weight. Executed in sparkling crystal this classic glass collection is perfectly balanced in the hand. RIEDEL VERITAS is designed based on the iconic RIEDEL Grape Varietal Specific bowls which bring optimum wine enjoyment.

The special production technology developed for RIEDEL VERITAS underlines RIEDEL's hallmark leadership in performance-driven crystal drinkware for consumers and professionals.







New World Shiraz



Cabernet/Merlot



Old World Pinot Noir



Old World Syrah

ITEM	Item no.: 6449/30 fine crystal premium machine-made	Item no.: 6449/0 fine crystal premium machine-made	Item no.: 6449/07 fine crystal premium machine-made	Item no.: 6449/41 fine crystal premium machine-made
	Height/glass: 246 mm Capacity/glass: 650 ccm Design: 2014	Height/glass: 235 mm Capacity/glass: 625 ccm Design: 2014	Height/glass: 235 mm Capacity/glass: 705 ccm Design: 2014	Height/glass: 235 mm Capacity/glass: 600 ccm Design: 2014
PACKAGING	Pieces/Bill unit: 2	Pieces/Bill unit: 2	Pieces/Bill unit: 2	Pieces/Bill unit: 2
TYPE AND QUANTITY	Bill units/MP: 4	Bill units/MP: 4	Bill units/MP: 4	Bill units/MP: 4
BILL UNIT	Length: 247 mm	Length: 247 mm	Length: 247 mm	Length: 247 mm
DIMENSIONS	Width: 126 mm	Width: 126 mm	Width: 126 mm	Width: 126 mm
	Height: 285 mm	Height: 285 mm	Height: 285 mm	Height: 285 mm
	Weight: 620 gr	Weight: 610 gr	Weight: 620 gr	Weight: 620 gr
MASTERPACK	Length: 502 mm	Length: 502 mm	Length: 502 mm	Length: 502 mm
DIMENSIONS	Width: 261 mm	Width: 261 mm	Width: 261 mm	Width: 261 mm
	Height: 295 mm	Height: 295 mm	Height: 295 mm	Height: 295 mm
	Weight: 2780 gr	Weight: 2740 gr	Weight: 2780 gr	Weight: 2780 gr
EURO PALLET	Bill units/pallet: 144	Bill units/pallet: 144	Bill units/pallet: 144	Bill units/pallet: 144
	Bill units/layer: 24	Bill units/layer: 24	Bill units/layer: 24	Bill units/layer: 24
	Layers/pallet: 6	Layers/pallet: 6	Layers/pallet: 6	Layers/pallet: 6
CONTAINER PALLET	Bill units/pallet: 224	Bill units/pallet: 224	Bill units/pallet: 224	Bill units/pallet: 224
HIGH CUBE	Bill units/layer: 32	Bill units/layer: 32	Bill units/layer: 32	Bill units/layer: 32
	Layers/pallet: 7	Layers/pallet: 7	Layers/pallet: 7	Layers/pallet: 7
EAN				
BILL UNIT				





New World Pinot Noir/Nebbiolo/
Rosé Champagne Glass



Champagne Wine Glass







Riesling/Zinfandel



Sauvignon Blanc

MACHINE-MADE

ITEM	Item no.: 6449/67 fine crystal premium machine-made	Item no.: 6449/28 fine crystal premium machine-made	Item no.: 6449/15 fine crystal premium machine-made	Item no.: 6449/33 fine crystal premium machine-made
	Height/glass: 235 mm Capacity/glass: 800 ccm Design: 2014	Height/glass: 235 mm Capacity/glass: 445 ccm Design: 2014	Height/glass: 235 mm Capacity/glass: 395 ccm Design: 2014	Height/glass: 235 mm Capacity/glass: 440 ccm Design: 2017
PACKAGING TYPE AND QUANTITY	Pieces/Bill unit: 2 Bill units/MP: 4	Pieces/Bill unit: 2 Bill units/MP: 4	Pieces/Bill unit: 2 Bill units/MP: 4	Pieces/Bill unit: 2 Bill units/MP: 4
BILL UNIT DIMENSIONS	Length: 247 mm Width: 126 mm Height: 285 mm Weight: 660 gr	Length: 247 mm Width: 126 mm Height: 285 mm Weight: 590 gr	Length: 247 mm Width: 126 mm Height: 285 mm Weight: 590 gr	Length: 247 mm Width: 126 mm Height: 285 mm Weight: 594 gr
MASTERPACK DIMENSIONS	Length: 502 mm Width: 261 mm Height: 295 mm Weight: 2940 gr	Length: 502 mm Width: 261 mm Height: 295 mm Weight: 2650 gr	Length: 502 mm Width: 261 mm Height: 295 mm Weight: 2650 gr	Length: 502 mm Width: 261 mm Height: 295 mm Weight: 2678 gr
EURO PALLET	Bill units/pallet: 144 Bill units/layer: 24 Layers/pallet: 6	Bill units/pallet: 144 Bill units/layer: 24 Layers/pallet: 6	Bill units/pallet: 144 Bill units/layer: 24 Layers/pallet: 6	Bill units/pallet: 144 Bill units/layer: 24 Layers/pallet: 6
CONTAINER PALLET HIGH CUBE	Bill units/pallet: 224 Bill units/layer: 32 Layers/pallet: 7	Bill units/pallet: 224 Bill units/layer: 32 Layers/pallet: 7	Bill units/pallet: 224 Bill units/layer: 32 Layers/pallet: 7	Bill units/pallet: 224 Bill units/layer: 32 Layers/pallet: 7
EAN BILL UNIT	 9 006206 522798	 9 006206 522866	 9 006206 522767	 9 006206 526048



Viognier/Chardonnay



Oaked Chardonnay



Coupe/Cocktail



Spirits

ITEM	Item no.: 6449/05 fine crystal premium machine-made	Item no.: 6449/97 fine crystal premium machine-made	Item no.: 6449/09 fine crystal premium machine-made	Item no.: 6449/71 fine crystal premium machine-made
	Height/glass: 225 mm Capacity/glass: 370 ccm Design: 2014	Height/glass: 217 mm Capacity/glass: 620 ccm Design: 2014	Height/glass: 170 mm Capacity/glass: 240 ccm Design: 2014	Height/glass: 235 mm Capacity/glass: 152 ccm Design: 2016
PACKAGING	Pieces/Bill unit: 2	Pieces/Bill unit: 2	Pieces/Bill unit: 2	Pieces/Bill unit: 2
TYPE AND QUANTITY	Bill units/MP: 4	Bill units/MP: 4	Bill units/MP: 4	Bill units/MP: 4
BILL UNIT	Length: 247 mm	Length: 247 mm	Length: 247 mm	Length: 247 mm
DIMENSIONS	Width: 126 mm	Width: 126 mm	Width: 126 mm	Width: 126 mm
	Height: 285 mm	Height: 285 mm	Height: 285 mm	Height: 285 mm
	Weight: 580 gr	Weight: 610 gr	Weight: 570 gr	Weight: 545 gr
MASTERPACK	Length: 502 mm	Length: 502 mm	Length: 502 mm	Length: 502 mm
DIMENSIONS	Width: 261 mm	Width: 261 mm	Width: 261 mm	Width: 261 mm
	Height: 295 mm	Height: 295 mm	Height: 295 mm	Height: 295 mm
	Weight: 2620 gr	Weight: 2740 gr	Weight: 2580 gr	Weight: 2500 gr
EURO PALLET	Bill units/pallet: 144	Bill units/pallet: 144	Bill units/pallet: 144	Bill units/pallet: 144
	Bill units/layer: 24	Bill units/layer: 24	Bill units/layer: 24	Bill units/layer: 24
	Layers/pallet: 6	Layers/pallet: 6	Layers/pallet: 6	Layers/pallet: 6
CONTAINER PALLET	Bill units/pallet: 224	Bill units/pallet: 224	Bill units/pallet: 224	Bill units/pallet: 224
HIGH CUBE	Bill units/layer: 32	Bill units/layer: 32	Bill units/layer: 32	Bill units/layer: 32
	Layers/pallet: 7	Layers/pallet: 7	Layers/pallet: 7	Layers/pallet: 7
EAN				
BILL UNIT	9 006206 522774	9 006206 522750	9 006206 522859	9 006206 525348





Beer



ITEM	Item no.: 6449/11 fine crystal premium machine-made
	Height/glass: 160 mm Capacity/glass: 435 ccm Design: 2016
PACKAGING	Pieces/Bill unit: 2
TYPE AND QUANTITY	Bill units/MP: 4
BILL UNIT	Length: 247 mm
DIMENSIONS	Width: 126 mm
	Height: 285 mm
	Weight: 570 gr
MASTERPACK	Length: 502 mm
DIMENSIONS	Width: 261 mm
	Height: 295 mm
	Weight: 2580 gr
EURO PALLET	Bill units/pallet: 144
	Bill units/layer: 24
	Layers/pallet: 6
CONTAINER PALLET	Bill units/pallet: 224
HIGH CUBE	Bill units/layer: 32
	Layers/pallet: 7
EAN BILL UNIT	 9 006206 525324



Red Wine Set

Cabernet/Merlot + Neue Welt Pinot Noir + Syrah

Champagne Tasting Set

ITEM	<p>Item no.: 5449/74</p> <p>fine crystal</p> <p>premium machine-made</p> <p>Height/glass: 235 mm</p> <p>Capacity/glass: -</p> <p>Design: 2014</p>	<p>Item no.: 5449/74-1</p> <p>fine crystal</p> <p>premium machine-made</p> <p>Height/glass: -</p> <p>Capacity/glass: -</p> <p>Design: 2020</p>
PACKAGING TYPE AND QUANTITY	<p>Pieces/Bill unit: 3</p> <p>Bill units/MP: 2</p>	<p>Pieces/Bill unit: 3</p> <p>Bill units/MP: 2</p>
BILL UNIT DIMENSIONS	<p>Length: 381 mm</p> <p>Width: 125 mm</p> <p>Height: 284 mm</p> <p>Weight: 1143 gr</p>	<p>Length: 381 mm</p> <p>Width: 125 mm</p> <p>Height: 284 mm</p> <p>Weight: 1123 gr</p>
MASTERPACK DIMENSIONS	<p>Length: 394 mm</p> <p>Width: 264 mm</p> <p>Height: 299 mm</p> <p>Weight: 2568 gr</p>	<p>Length: 394 mm</p> <p>Width: 264 mm</p> <p>Height: 299 mm</p> <p>Weight: 2528 gr</p>
EURO PALLET	<p>Bill units/pallet: 108</p> <p>Bill units/layer: 18</p> <p>Layers/pallet: 6</p>	<p>Bill units/pallet: 108</p> <p>Bill units/layer: 18</p> <p>Layers/pallet: 6</p>
CONTAINER PALLET HIGH CUBE	<p>Bill units/pallet: 168</p> <p>Bill units/layer: 24</p> <p>Layers/pallet: 7</p>	<p>Bill units/pallet: 168</p> <p>Bill units/layer: 24</p> <p>Layers/pallet: 7</p>
EAN BILL UNIT	 <p>9 006206 522996</p>	 <p>9 006206 530700</p>





RIEDEL Veritas Cabernet/Merlot
Value Gift Pack - Pay 6 Get 8



RIEDEL Veritas Champagne Glass
Value Gift Pack - Pay 6 Get 8

MACHINE-MADE

ITEM	Item no.: 7449/0 fine crystal machine-made	Item no.: 7449/28 fine crystal machine-made
	Height/glass: 235 mm Capacity/glass: 625 ccm Design: 2019	Height/glass: 235 mm Capacity/glass: 445 ccm Design: 2019
PACKAGING	Pieces/Bill unit: 8	Pieces/Bill unit: 8
TYPE AND QUANTITY	Bill units/MP: 1	Bill units/MP: 1
BILL UNIT	Length: 488 mm	Length: 488 mm
DIMENSIONS	Width: 249 mm	Width: 249 mm
	Height: 290 mm	Height: 290 mm
	Weight: 2260 gr	Weight: 2180 gr
MASTERPACK	Length: 491 mm	Length: 491 mm
DIMENSIONS	Width: 257 mm	Width: 257 mm
	Height: 299 mm	Height: 299 mm
	Weight: 2480 gr	Weight: 2400 gr
EURO PALLET	Bill units/pallet: 42	Bill units/pallet: 42
	Bill units/layer: 6	Bill units/layer: 6
	Layers/pallet: 7	Layers/pallet: 7
CONTAINER PALLET	Bill units/pallet: 72	Bill units/pallet: 72
HIGH CUBE	Bill units/layer: 8	Bill units/layer: 8
	Layers/pallet: 9	Layers/pallet: 9
EAN	 9 006206 524259	 9 006206 524310
BILL UNIT		





performance

RIEDEL PERFORMANCE (2018)

With three generations of research, development and experience in creating wine specific glassware Georg Riedel & Maximilian J. Riedel have created Performance; the new ultimate loudspeaker for fine wine. Lightweight, durable and dishwasher-safe, Performance glasses are executed in sparkling fine crystal, and feature long fine stems and large stable bases. Performance's unique optic impact not only adds a pleasing visual aspect to the bowl, but also increases the inner surface area, allowing the wine to open up and to fully show every aroma and subtle nuance. The grape varietal specific shapes in Performance, when combined with the optic impact, deliver ultimate wine enjoyment, making Performance the new essential 'must-have' wine glass collection for all wine-lovers.





Cabernet/Merlot



Pinot Noir



Syrah/Shiraz



Champagne Glass

ITEM	Item no.: 6884/0 fine crystal premium machine-made	Item no.: 6884/67 fine crystal premium machine-made	Item no.: 6884/41 fine crystal premium machine-made	Item no.: 6884/28 fine crystal premium machine-made
	Height/glass: 245 mm	Height/glass: 245 mm	Height/glass: 245 mm	Height/glass: 245 mm
	Capacity/glass: 834 ccm	Capacity/glass: 830 ccm	Capacity/glass: 631 ccm	Capacity/glass: 375 ccm
	Design: 2018	Design: 2018	Design: 2018	Design: 2018
PACKAGING	Pieces/Bill unit: 2	Pieces/Bill unit: 2	Pieces/Bill unit: 2	Pieces/Bill unit: 2
TYPE AND QUANTITY	Bill units/MP: 4	Bill units/MP: 4	Bill units/MP: 4	Bill units/MP: 4
BILL UNIT	Length: 289 mm	Length: 289 mm	Length: 289 mm	Length: 289 mm
DIMENSIONS	Width: 128 mm	Width: 128 mm	Width: 128 mm	Width: 128 mm
	Height: 283 mm	Height: 283 mm	Height: 283 mm	Height: 283 mm
	Weight: 694 gr	Weight: 694 gr	Weight: 684 gr	Weight: 644 gr
MASTERPACK	Length: 529 mm	Length: 529 mm	Length: 529 mm	Length: 529 mm
DIMENSIONS	Width: 299 mm	Width: 299 mm	Width: 299 mm	Width: 299 mm
	Height: 298 mm	Height: 298 mm	Height: 298 mm	Height: 298 mm
	Weight: 3160 gr	Weight: 3121 gr	Weight: 3081 gr	Weight: 2921 gr
EURO PALLET	Bill units/pallet: 96	Bill units/pallet: 96	Bill units/pallet: 96	Bill units/pallet: 96
	Bill units/layer: 16	Bill units/layer: 16	Bill units/layer: 16	Bill units/layer: 16
	Layers/pallet: 6	Layers/pallet: 6	Layers/pallet: 6	Layers/pallet: 6
CONTAINER PALLET	Bill units/pallet: 224	Bill units/pallet: 224	Bill units/pallet: 224	Bill units/pallet: 224
HIGH CUBE	Bill units/layer: 32	Bill units/layer: 32	Bill units/layer: 32	Bill units/layer: 32
	Layers/pallet: 7	Layers/pallet: 7	Layers/pallet: 7	Layers/pallet: 7
EAN				
BILL UNIT				



OPTIC IMPACT

Performance's unique optic impact not only adds a pleasing visual aspect to the bowl, but also increases the inner surface area, allowing the wine to open up and to fully show every aroma and subtle nuance.





Sauvignon Blanc



Riesling



Chardonnay

ITEM	Item no.: 6884/33 fine crystal premium machine-made	Item no.: 6884/15 fine crystal premium machine-made	Item no.: 6884/97 fine crystal premium machine-made
	Height/glass: 245 mm Capacity/glass: 440 ccm Design: 2019	Height/glass: 245 mm Capacity/glass: 623 ccm Design: 2018	Height/glass: 245 mm Capacity/glass: 727 ccm Design: 2018
PACKAGING	Pieces/Bill unit: 2	Pieces/Bill unit: 2	Pieces/Bill unit: 2
TYPE AND QUANTITY	Bill units/MP: 4	Bill units/MP: 4	Bill units/MP: 4
BILL UNIT	Length: 289 mm	Length: 289 mm	Length: 289 mm
DIMENSIONS	Width: 128 mm	Width: 128 mm	Width: 128 mm
	Height: 283 mm	Height: 283 mm	Height: 283 mm
	Weight: 664 gr	Weight: 664 gr	Weight: 694 gr
MASTERPACK	Length: 529 mm	Length: 529 mm	Length: 529 mm
DIMENSIONS	Width: 299 mm	Width: 299 mm	Width: 299 mm
	Height: 298 mm	Height: 298 mm	Height: 298 mm
	Weight: 3001 gr	Weight: 3001 gr	Weight: 3121 gr
EURO PALLET	Bill units/pallet: 96	Bill units/pallet: 96	Bill units/pallet: 96
	Bill units/layer: 16	Bill units/layer: 16	Bill units/layer: 16
	Layers/pallet: 6	Layers/pallet: 6	Layers/pallet: 6
CONTAINER PALLET	Bill units/pallet: 224	Bill units/pallet: 224	Bill units/pallet: 224
HIGH CUBE	Bill units/layer: 32	Bill units/layer: 32	Bill units/layer: 32
	Layers/pallet: 7	Layers/pallet: 7	Layers/pallet: 7
EAN BILL UNIT	 9 006206 529407	 9 006206 527366	 9 006206 527373





Tasting Set

Cabernet/Merlot + Pinot Noir + Sauvignon Blanc + Chardonnay

ITEM	<p>Item no.: 5884/47-19</p> <p>fine crystal</p> <p>premium machine-made</p> <p>Height/glass: 245 mm</p> <p>Capacity/glass: -</p> <p>Design: 2018</p>
PACKAGING	<p>Pieces/Bill unit: 4</p>
TYPE AND QUANTITY	<p>Bill units/MP: 2</p>
BILL UNIT	<p>Length: 577 mm</p>
DIMENSIONS	<p>Width: 127 mm</p> <p>Height: 286 mm</p> <p>Weight: 1487 gr</p>
MASTERPACK	<p>Length: 587 mm</p>
DIMENSIONS	<p>Width: 271 mm</p> <p>Height: 297 mm</p> <p>Weight: 3310 gr</p>
EURO PALLET	<p>Bill units/pallet: 8</p> <p>Bill units/layer: 8</p> <p>Layers/pallet: 6</p>
CONTAINER PALLET	<p>Bill units/pallet: 84</p>
HIGH CUBE	<p>Bill units/layer: 12</p> <p>Layers/pallet: 7</p>
EAN	<p>9 006206 530069</p>
BILL UNIT	





MACHINE-MADE

vinum

VINUM (1986) RIEDEL'S BENCHMARK

VINUM was the first machine-made glass collection in history to be based on the characteristics of grape varieties. Grape varieties carry in their DNA unmistakable flavor profiles, which add to the importance of selecting the appropriate glass.

VINUM was developed by Georg J. Riedel, not on a drawing board but through sensory workshops - a concept where the performance and the content command the shape - and which was developed by the RIEDEL family.

VINUM is the „Vitrum-Vinothek“ for everyday use.





MACHINE-MADE



Bordeaux Grand Cru







Syrah/Shiraz



Cabernet Sauvignon/Merlot



New World Pinot Noir

ITEM	Item no.: 6416/00 fine crystal premium machine-made	Item no.: 6416/30 fine crystal premium machine-made	Item no.: 6416/0 fine crystal premium machine-made	Item no.: 6416/16 fine crystal premium machine-made
	Height/glass: 265 mm Capacity/glass: 960 ccm Design: 2008	Height/glass: 236 mm Capacity/glass: 700 ccm Design: 1995	Height/glass: 225 mm Capacity/glass: 610 ccm Design: 1986	Height/glass: 225 mm Capacity/glass: 800 ccm Design: 2018
PACKAGING	Pieces/Bill unit: 2	Pieces/Bill unit: 2	Pieces/Bill unit: 2	Pieces/Bill unit: 2
TYPE AND QUANTITY	Bill units/MP: 4	Bill units/MP: 4	Bill units/MP: 4	Bill units/MP: 4
BILL UNIT	Length: 290 mm	Length: 227 mm	Length: 227 mm	Length: 227 mm
DIMENSIONS	Width: 266 mm	Width: 116 mm	Width: 116 mm	Width: 116 mm
	Height: 297 mm	Height: 275 mm	Height: 275 mm	Height: 275 mm
	Weight: 744 gr	Weight: 622 gr	Weight: 612 gr	Weight: 612 gr
MASTERPACK	Length: 542 mm	Length: 469 mm	Length: 469 mm	Length: 469 mm
DIMENSIONS	Width: 304 mm	Width: 235 mm	Width: 235 mm	Width: 235 mm
	Height: 309 mm	Height: 285 mm	Height: 285 mm	Height: 285 mm
	Weight: 3358 gr	Weight: 2792 gr	Weight: 2752 gr	Weight: 2752 gr
EURO PALLET	Bill units/pallet: 96	Bill units/pallet: 168	Bill units/pallet: 168	Bill units/pallet: 168
	Bill units/layer: 16	Bill units/layer: 28	Bill units/layer: 28	Bill units/layer: 28
	Layers/pallet: 6	Layers/pallet: 6	Layers/pallet: 6	Layers/pallet: 6
CONTAINER PALLET	Bill units/pallet: 168	Bill units/pallet: 320	Bill units/pallet: 320	Bill units/pallet: 320
HIGH CUBE	Bill units/layer: 24	Bill units/layer: 40	Bill units/layer: 40	Bill units/layer: 40
	Layers/pallet: 7	Layers/pallet: 8	Layers/pallet: 8	Layers/pallet: 8
EAN	 9 006206 514762	 9 006206 513871	 9 006206 512119	 9 006206 527601
BILL UNIT				





Pinot Noir (Burgundy Red)



Zinfandel



Sauvignon Blanc



Riesling Grand Cru

MACHINE-MADE

ITEM	Item no.: 6416/07 fine crystal premium machine-made	Item no.: 6416/15 fine crystal premium machine-made	Item no.: 6416/33 fine crystal premium machine-made	Item no.: 6416/15 fine crystal premium machine-made
	Height/glass: 210 mm Capacity/glass: 700 ccm Design: 1986	Height/glass: 210 mm Capacity/glass: 400 ccm Design: 1992	Height/glass: 214 mm Capacity/glass: 350 ccm Design: 1998	Height/glass: 210 mm Capacity/glass: 400 ccm Design: 1992
PACKAGING	Pieces/Bill unit: 2	Pieces/Bill unit: 2	Pieces/Bill unit: 2	Pieces/Bill unit: 2
TYPE AND QUANTITY	Bill units/MP: 4	Bill units/MP: 4	Bill units/MP: 4	Bill units/MP: 4
BILL UNIT	Length: 227 mm	Length: 227 mm	Length: 227 mm	Length: 227 mm
DIMENSIONS	Width: 116 mm	Width: 116 mm	Width: 116 mm	Width: 116 mm
	Height: 275 mm	Height: 275 mm	Height: 275 mm	Height: 275 mm
	Weight: 622 gr	Weight: 572 gr	Weight: 592 gr	Weight: 572 gr
MASTERPACK	Length: 469 mm	Length: 469 mm	Length: 469 mm	Length: 469 mm
DIMENSIONS	Width: 235 mm	Width: 235 mm	Width: 235 mm	Width: 235 mm
	Height: 285 mm	Height: 285 mm	Height: 285 mm	Height: 285 mm
	Weight: 2792 gr	Weight: 2592 gr	Weight: 2672 gr	Weight: 2592 gr
EURO PALLET	Bill units/pallet: 168	Bill units/pallet: 168	Bill units/pallet: 168	Bill units/pallet: 168
	Bill units/layer: 28	Bill units/layer: 28	Bill units/layer: 28	Bill units/layer: 28
	Layers/pallet: 6	Layers/pallet: 6	Layers/pallet: 6	Layers/pallet: 6
CONTAINER PALLET	Bill units/pallet: 320	Bill units/pallet: 320	Bill units/pallet: 320	Bill units/pallet: 320
HIGH CUBE	Bill units/layer: 40	Bill units/layer: 40	Bill units/layer: 40	Bill units/layer: 40
	Layers/pallet: 8	Layers/pallet: 8	Layers/pallet: 8	Layers/pallet: 8
EAN				
BILL UNIT				



Daiginjo







Viognier/Chardonnay



Oaked Chardonnay (Montrachet)



Vintage Champagne Glass

ITEM	Item no.: fine crystal premium machine-made	0416/75	Item no.: fine crystal premium machine-made	6416/05	Item no.: fine crystal premium machine-made	6416/97	Item no.: fine crystal premium machine-made	6416/28
	Height/glass:	205 mm	Height/glass:	198 mm	Height/glass:	192 mm	Height/glass:	252 mm
	Capacity/glass:	380 ccm	Capacity/glass:	350 ccm	Capacity/glass:	600 ccm	Capacity/glass:	364 ccm
	Design:	1999	Design:	1986	Design:	2000	Design:	2008
PACKAGING	Pieces/Bill unit:	1	Pieces/Bill unit:	2	Pieces/Bill unit:	2	Pieces/Bill unit:	2
TYPE AND QUANTITY	Bill units/MP:	6	Bill units/MP:	4	Bill units/MP:	4	Bill units/MP:	4
BILL UNIT	Length:	106 mm	Length:	227 mm	Length:	227 mm	Length:	290 mm
DIMENSIONS	Width:	142 mm	Width:	116 mm	Width:	116 mm	Width:	266 mm
	Height:	229 mm	Height:	275 mm	Height:	275 mm	Height:	297 mm
	Weight:	290 gr	Weight:	562 gr	Weight:	612 gr	Weight:	644 gr
MASTERPACK	Length:	331 mm	Length:	469 mm	Length:	469 mm	Length:	542 mm
DIMENSIONS	Width:	226 mm	Width:	235 mm	Width:	235 mm	Width:	304 mm
	Height:	290 mm	Height:	285 mm	Height:	285 mm	Height:	309 mm
	Weight:	2040 gr	Weight:	2552 gr	Weight:	2752 gr	Weight:	2958 gr
EURO PALLET	Bill units/pallet:	396	Bill units/pallet:	168	Bill units/pallet:	168	Bill units/pallet:	96
	Bill units/layer:	66	Bill units/layer:	28	Bill units/layer:	28	Bill units/layer:	16
	Layers/pallet:	6	Layers/pallet:	6	Layers/pallet:	6	Layers/pallet:	6
CONTAINER PALLET	Bill units/pallet:	768	Bill units/pallet:	320	Bill units/pallet:	320	Bill units/pallet:	168
HIGH CUBE	Bill units/layer:	96	Bill units/layer:	40	Bill units/layer:	40	Bill units/layer:	24
	Layers/pallet:	8	Layers/pallet:	8	Layers/pallet:	8	Layers/pallet:	7
EAN	 9 006206 510825		 9 006206 513901		 9 006206 513895		 9 006206 514724	
BILL UNIT								





Champagne Flute



Champagne Wine Glass







Cuvée Prestige



Cognac

MACHINE-MADE

ITEM	Item no.: 6416/08 fine crystal premium machine-made	Item no.: 6416/58 fine crystal premium machine-made	Item no.: 6416/48 fine crystal premium machine-made	Item no.: 6416/71 fine crystal premium machine-made
	Height/glass: 226 mm Capacity/glass: 160 ccm Design: 1986	Height/glass: 225 mm Capacity/glass: 445 ccm Design: 2018	Height/glass: 218 mm Capacity/glass: 230 ccm Design: 1999	Height/glass: 184 mm Capacity/glass: 170 ccm Design: 1998
PACKAGING	Pieces/Bill unit: 2	Pieces/Bill unit: 2	Pieces/Bill unit: 2	Pieces/Bill unit: 2
TYPE AND QUANTITY	Bill units/MP: 4	Bill units/MP: 4	Bill units/MP: 4	Bill units/MP: 4
BILL UNIT	Length: 227 mm	Length: 227 mm	Length: 227 mm	Length: 227 mm
DIMENSIONS	Width: 116 mm	Width: 116 mm	Width: 116 mm	Width: 116 mm
	Height: 275 mm	Height: 275 mm	Height: 275 mm	Height: 275 mm
	Weight: 562 gr	Weight: 622 gr	Weight: 542 gr	Weight: 532 gr
MASTERPACK	Length: 469 mm	Length: 469 mm	Length: 469 mm	Length: 469 mm
DIMENSIONS	Width: 235 mm	Width: 235 mm	Width: 235 mm	Width: 235 mm
	Height: 285 mm	Height: 285 mm	Height: 285 mm	Height: 285 mm
	Weight: 2552 gr	Weight: 2792 gr	Weight: 2472 gr	Weight: 2432 gr
EURO PALLET	Bill units/pallet: 168	Bill units/pallet: 168	Bill units/pallet: 168	Bill units/pallet: 168
	Bill units/layer: 28	Bill units/layer: 28	Bill units/layer: 28	Bill units/layer: 28
	Layers/pallet: 6	Layers/pallet: 6	Layers/pallet: 6	Layers/pallet: 6
CONTAINER PALLET	Bill units/pallet: 320	Bill units/pallet: 320	Bill units/pallet: 320	Bill units/pallet: 320
HIGH CUBE	Bill units/layer: 40	Bill units/layer: 40	Bill units/layer: 40	Bill units/layer: 40
	Layers/pallet: 8	Layers/pallet: 8	Layers/pallet: 8	Layers/pallet: 8
EAN				
BILL UNIT	9 006206 514038	9 006206 527175	9 006206 512409	9 006206 513710



Port







Gourmet Glass



Brandy



Water

ITEM	Item no.: 6416/60 fine crystal premium machine-made	Item no.: 6416/21 fine crystal premium machine-made	Item no.: 6416/18 fine crystal premium machine-made	Item no.: 6416/02 fine crystal premium machine-made
	Height/glass: 168 mm Capacity/glass: 240 ccm Design: 1991	Height/glass: 156 mm Capacity/glass: 370 ccm Design: 1997	Height/glass: 151 mm Capacity/glass: 885 ccm Design: 1998	Height/glass: 145 mm Capacity/glass: 350 ccm Design: 1991
PACKAGING TYPE AND QUANTITY	Pieces/Bill unit: 2 Bill units/MP: 4	Pieces/Bill unit: 2 Bill units/MP: 4	Pieces/Bill unit: 2 Bill units/MP: 4	Pieces/Bill unit: 2 Bill units/MP: 4
BILL UNIT DIMENSIONS	Length: 272 mm Width: 138 mm Height: 205 mm Weight: 530 gr	Length: 272 mm Width: 138 mm Height: 205 mm Weight: 520 gr	Length: 272 mm Width: 138 mm Height: 205 mm Weight: 576 gr	Length: 272 mm Width: 138 mm Height: 205 mm Weight: 514 gr
MASTERPACK DIMENSIONS	Length: 573 mm Width: 283 mm Height: 215 mm Weight: 2463 gr	Length: 573 mm Width: 283 mm Height: 215 mm Weight: 2423 gr	Length: 573 mm Width: 283 mm Height: 215 mm Weight: 2627 gr	Length: 573 mm Width: 283 mm Height: 215 mm Weight: 2399 gr
EURO PALLET	Bill units/pallet: 144 Bill units/layer: 16 Layers/pallet: 9	Bill units/pallet: 144 Bill units/layer: 16 Layers/pallet: 9	Bill units/pallet: 144 Bill units/layer: 16 Layers/pallet: 9	Bill units/pallet: 144 Bill units/layer: 16 Layers/pallet: 9
CONTAINER PALLET HIGH CUBE	Bill units/pallet: 264 Bill units/layer: 24 Layers/pallet: 11	Bill units/pallet: 264 Bill units/layer: 24 Layers/pallet: 11	Bill units/pallet: 264 Bill units/layer: 24 Layers/pallet: 11	Bill units/pallet: 264 Bill units/layer: 24 Layers/pallet: 11
EAN BILL UNIT	 9 006206 513741	 9 006206 514076	 9 006206 514045	 9 006206 514069









Martini



Single Malt Whisky

ITEM	Item no.: 6416/77 fine crystal premium machine-made	Item no.: 6416/80 fine crystal premium machine-made
	Height/glass: 147 mm	Height/glass: 113 mm
	Capacity/glass: 155 ccm	Capacity/glass: 200 ccm
	Design: 1997	Design: 1991
PACKAGING	Pieces/Bill unit: 2	Pieces/Bill unit: 2
TYPE AND QUANTITY	Bill units/MP: 4	Bill units/MP: 4
BILL UNIT	Length: 272 mm	Length: 272 mm
DIMENSIONS	Width: 138 mm	Width: 138 mm
	Height: 205 mm	Height: 205 mm
	Weight: 510 gr	Weight: 510 gr
MASTERPACK	Length: 573 mm	Length: 573 mm
DIMENSIONS	Width: 283 mm	Width: 283 mm
	Height: 215 mm	Height: 215 mm
	Weight: 2383 gr	Weight: 2383 gr
EURO PALLET	Bill units/pallet: 144	Bill units/pallet: 144
	Bill units/layer: 16	Bill units/layer: 16
	Layers/pallet: 9	Layers/pallet: 9
CONTAINER PALLET	Bill units/pallet: 264	Bill units/pallet: 264
HIGH CUBE	Bill units/layer: 24	Bill units/layer: 24
	Layers/pallet: 11	Layers/pallet: 11
EAN BILL UNIT	 9 006206 514052	 9 006206 513727



Cabernet/Merlot
Value Gift Pack - Pay 3 Get 4



Viognier/Chardonnay
Value Gift Pack - Pay 3 Get 4

MACHINE-MADE

ITEM	Item no.: 5416/0 fine crystal premium machine-made Height/glass: 225 mm Capacity/glass: 610 ccm Design: 2022	Item no.: 5416/05 fine crystal premium machine-made Height/glass: 198 mm Capacity/glass: 350 ccm Design: 2022
PACKAGING TYPE AND QUANTITY	Pieces/Bill unit: 4 Bill units/MP: 2	Pieces/Bill unit: 4 Bill units/MP: 2
BILL UNIT DIMENSIONS	Length: 225 mm Width: 225 mm Height: 274 mm Weight: 1123 gr	Length: 225 mm Width: 225 mm Height: 274 mm Weight: 1023 gr
MASTERPACK DIMENSIONS	Length: 459 mm Width: 236 mm Height: 287 mm Weight: 2525 gr	Length: 459 mm Width: 236 mm Height: 287 mm Weight: 2325 gr
EURO PALLET	Bill units/pallet: 84 Bill units/layer: 14 Layers/pallet: 6	Bill units/pallet: 84 Bill units/layer: 14 Layers/pallet: 6
CONTAINER PALLET HIGH CUBE	Bill units/pallet: 160 Bill units/layer: 20 Layers/pallet: 8	Bill units/pallet: 160 Bill units/layer: 20 Layers/pallet: 8
EAN BILL UNIT		







VINUM Cabernet Sauvignon/Merlot
Value Gift Pack - Pay 6 Get 8



VINUM Viognier/Chardonnay
Value Gift Pack - Pay 6 Get 8

ITEM	Item no.:	7416/0	Item no.:	7416/05
	fine crystal machine-made		fine crystal machine-made	
	Height/glass:	225 mm	Height/glass:	198 mm
	Capacity/glass:	610 ccm	Capacity/glass:	350 ccm
	Design:	2015	Design:	2015
PACKAGING TYPE AND QUANTITY	Pieces/Bill unit:	8	Pieces/Bill unit:	8
	Bill units/MP:	1	Bill units/MP:	1
BILL UNIT DIMENSIONS	Length:	447 mm	Length:	447 mm
	Width:	236 mm	Width:	236 mm
	Height:	282 mm	Height:	282 mm
	Weight:	2347 gr	Weight:	2035 gr
MASTERPACK DIMENSIONS	Length:	457 mm	Length:	457 mm
	Width:	255 mm	Width:	255 mm
	Height:	306 mm	Height:	306 mm
	Weight:	2690 gr	Weight:	2366 gr
EURO PALLET	Bill units/pallet:	42	Bill units/pallet:	42
	Bill units/layer:	7	Bill units/layer:	7
	Layers/pallet:	6	Layers/pallet:	6
CONTAINER PALLET HIGH CUBE	Bill units/pallet:	70	Bill units/pallet:	70
	Bill units/layer:	10	Bill units/layer:	10
	Layers/pallet:	7	Layers/pallet:	7
EAN BILL UNIT	 9 006206 515066		 9 006206 515073	





VINUM + Gift
2x Cabernet Sauvignon + 1x Polishing Cloth

ITEM	Item no.: 6416/0-POL fine crystal machine-made
	Height/glass: 225 mm Capacity/glass: 610 ccm Design: 2021
PACKAGING TYPE AND QUANTITY	Pieces/Bill unit: 2 Bill units/MP: 4
BILL UNIT DIMENSIONS	Length: 227 mm Width: 116 mm Height: 275 mm Weight: 612 gr
MASTERPACK DIMENSIONS	Length: 469 mm Width: 235 mm Height: 285 mm Weight: 2752 gr
EURO PALLET	Bill units/pallet: 168 Bill units/layer: 28 Layers/pallet: 6
CONTAINER PALLET HIGH CUBE	Bill units/pallet: 320 Bill units/layer: 40 Layers/pallet: 8
EAN BILL UNIT	 9 006206 321353



MACHINE-MADE IN AMBERG, GERMANY





MACHINE MADE - BLOWN IN AMBERG, GERMANY
fine crystal, machine-made, fully automated production

X
EXTREME



EXTREME (2020)
DRAMATICALLY DESIGNED FOR NEW WORLD WINES

EXTREME was developed in sensory workshops by experts and are specially designed for the optimum enjoyment of wines. Executed in clear, brilliant crystal by RIEDEL in Bavaria, Germany, EXTREME perfectly shows the true colours and depths of the wine. These glasses feature a broad, angled, grape varietal specific bowl, which enhances the wine's aromas, opening up the wine to reveal every subtle nuance. EXTREME delivers the wine perfectly onto the palate, balancing and harmonising the fruit, acidity and tannins and highlighting the wine's delicious flavours.



Cabernet



Pinot Noir



Shiraz



Riesling/Sauvignon Blanc

ITEM	Item no.: fine crystal machine-made	4441/0	Item no.: fine crystal machine-made	4441/07	Item no.: fine crystal machine-made	4441/32	Item no.: fine crystal machine-made	4441/15
	Height/glass:	247 mm	Height/glass:	243 mm	Height/glass:	244 mm	Height/glass:	240 mm
	Capacity/glass:	800 ccm	Capacity/glass:	770 ccm	Capacity/glass:	709 ccm	Capacity/glass:	490 ccm
	Design:	2018	Design:	2018	Design:	2018	Design:	2018
PACKAGING	Pieces/Bill unit:	2	Pieces/Bill unit:	2	Pieces/Bill unit:	2	Pieces/Bill unit:	2
TYPE AND QUANTITY	Bill units/MP:	4	Bill units/MP:	4	Bill units/MP:	4	Bill units/MP:	4
BILL UNIT	Length:	263 mm	Length:	263 mm	Length:	263 mm	Length:	263 mm
DIMENSIONS	Width:	135 mm	Width:	135 mm	Width:	135 mm	Width:	135 mm
	Height:	279 mm	Height:	279 mm	Height:	279 mm	Height:	279 mm
	Weight:	710 gr	Weight:	710 gr	Weight:	702 gr	Weight:	658 gr
MASTERPACK	Length:	531 mm	Length:	531 mm	Length:	531 mm	Length:	531 mm
DIMENSIONS	Width:	278 mm	Width:	278 mm	Width:	278 mm	Width:	278 mm
	Height:	290 mm	Height:	290 mm	Height:	290 mm	Height:	290 mm
	Weight:	3262 gr	Weight:	3262 gr	Weight:	3230 gr	Weight:	3054 gr
EURO PALLET	Bill units/pallet:	144	Bill units/pallet:	144	Bill units/pallet:	144	Bill units/pallet:	144
	Bill units/layer:	24	Bill units/layer:	24	Bill units/layer:	24	Bill units/layer:	24
	Layers/pallet:	6	Layers/pallet:	6	Layers/pallet:	6	Layers/pallet:	6
CONTAINER PALLET	Bill units/pallet:	256	Bill units/pallet:	256	Bill units/pallet:	256	Bill units/pallet:	256
HIGH CUBE	Bill units/layer:	32	Bill units/layer:	32	Bill units/layer:	32	Bill units/layer:	32
	Layers/pallet:	8	Layers/pallet:	8	Layers/pallet:	8	Layers/pallet:	8
EAN								
BILL UNIT	9 006206 526543		9 006206 526550		9 006206 526581		9 006206 526598	





Oaked Chardonnay



Rosé Champagne Glass/
Rosé Wine







Junmai



Martini

MACHINE-MADE

ITEM	Item no.: fine crystal machine-made	4441/97	Item no.: fine crystal machine-made	4441/55	Item no.: fine crystal machine-made	4441/27	Item no.: fine crystal machine-made	4441/17
	Height/glass:	227 mm	Height/glass:	230 mm	Height/glass:	200 mm	Height/glass:	175 mm
	Capacity/glass:	670 ccm	Capacity/glass:	322 ccm	Capacity/glass:	495 ccm	Capacity/glass:	250 ccm
	Design:	2018	Design:	2018	Design:	2018	Design:	2018
PACKAGING	Pieces/Bill unit:	2	Pieces/Bill unit:	2	Pieces/Bill unit:	2	Pieces/Bill unit:	2
TYPE AND QUANTITY	Bill units/MP:	4	Bill units/MP:	4	Bill units/MP:	4	Bill units/MP:	4
BILL UNIT	Length:	263 mm	Length:	263 mm	Length:	263 mm	Length:	263 mm
DIMENSIONS	Width:	135 mm	Width:	135 mm	Width:	135 mm	Width:	135 mm
	Height:	279 mm	Height:	279 mm	Height:	279 mm	Height:	279 mm
	Weight:	690 gr	Weight:	634 gr	Weight:	650 gr	Weight:	644 gr
MASTERPACK	Length:	531 mm	Length:	531 mm	Length:	531 mm	Length:	531 mm
DIMENSIONS	Width:	278 mm	Width:	278 mm	Width:	278 mm	Width:	278 mm
	Height:	290 mm	Height:	290 mm	Height:	290 mm	Height:	290 mm
	Weight:	3182 gr	Weight:	2958 gr	Weight:	3022 gr	Weight:	2998 gr
EURO PALLET	Bill units/pallet:	144	Bill units/pallet:	144	Bill units/pallet:	144	Bill units/pallet:	144
	Bill units/layer:	24	Bill units/layer:	24	Bill units/layer:	24	Bill units/layer:	24
	Layers/pallet:	6	Layers/pallet:	6	Layers/pallet:	6	Layers/pallet:	6
CONTAINER PALLET	Bill units/pallet:	256	Bill units/pallet:	256	Bill units/pallet:	256	Bill units/pallet:	256
HIGH CUBE	Bill units/layer:	32	Bill units/layer:	32	Bill units/layer:	32	Bill units/layer:	32
	Layers/pallet:	8	Layers/pallet:	8	Layers/pallet:	8	Layers/pallet:	8
EAN								
BILL UNIT	9 006206 526574		9 006206 526567		9 006206 527977		9 006206 526604	



Gin Set

ITEM	Item no.:	5441/97
	fine crystal machine-made	
	Height/glass:	227 mm
	Capacity/glass:	670 ccm
PACKAGING TYPE AND QUANTITY	Design:	2019
	Pieces/Bill unit:	4
BILL UNIT DIMENSIONS	Bill units/MP:	2
	Length:	236 mm
	Width:	234 mm
	Height:	235 mm
MASTERPACK DIMENSIONS	Weight:	944 gr
	Length:	477 mm
	Width:	244 mm
	Height:	249 mm
EURO PALLET	Weight:	2170 gr
	Bill units/pallet:	84
	Bill units/layer:	12
CONTAINER PALLET HIGH CUBE	Layers/pallet:	7
	Bill units/pallet:	180
	Bill units/layer:	20
EAN BILL UNIT	Layers/pallet:	9
	 9 006206 529865	





MACHINE-MADE



Extreme Cabernet
Value Gift Pack - Pay 3 Get 4



Extreme Pinot Noir
Value Gift Pack - Pay 3 Get 4

ITEM	Item no.:	4411/0	Item no.:	4411/07
	fine crystal		fine crystal	
	machine-made		machine-made	
	Height/glass:	247 mm	Height/glass:	243 mm
Capacity/glass:	800 ccm	Capacity/glass:	770 ccm	
Design:	2018	Design:	2018	
PACKAGING	Pieces/Bill unit:	4	Pieces/Bill unit:	4
TYPE AND QUANTITY	Bill units/MP:	2	Bill units/MP:	2
BILL UNIT	Length:	270 mm	Length:	270 mm
DIMENSIONS	Width:	263 mm	Width:	263 mm
	Height:	278 mm	Height:	278 mm
	Weight:	1367 gr	Weight:	1367 gr
	MASTERPACK	Length:	534 mm	Length:
DIMENSIONS	Width:	282 mm	Width:	282 mm
	Height:	296 mm	Height:	296 mm
	Weight:	3103 gr	Weight:	3103 gr
	EURO PALLET	Bill units/pallet:	48	Bill units/pallet:
	Bill units/layer:	8	Bill units/layer:	8
	Layers/pallet:	6	Layers/pallet:	6
CONTAINER PALLET	Bill units/pallet:	112	Bill units/pallet:	112
HIGH CUBE	Bill units/layer:	16	Bill units/layer:	16
	Layers/pallet:	7	Layers/pallet:	7
	EAN			
BILL UNIT				





Extreme Riesling
Value Gift Pack - Pay 3 Get 4



Extreme Rosé Champagne Glass/Rosé Wine
Value Gift Pack - Pay 3 Get 4

ITEM	Item no.:	4411/15	Item no.:	4411/55
	fine crystal machine-made		fine crystal machine-made	
	Height/glass:	240 mm	Height/glass:	230 mm
PACKAGING TYPE AND QUANTITY	Capacity/glass:	490 ccm	Capacity/glass:	322 ccm
	Design:	2018	Design:	2018
	Pieces/Bill unit:	4	Pieces/Bill unit:	4
BILL UNIT DIMENSIONS	Bill units/MP:	2	Bill units/MP:	2
	Length:	270 mm	Length:	270 mm
	Width:	263 mm	Width:	263 mm
	Height:	278 mm	Height:	278 mm
MASTERPACK DIMENSIONS	Weight:	1263 gr	Weight:	1215 gr
	Length:	534 mm	Length:	534 mm
	Width:	282 mm	Width:	282 mm
	Height:	296 mm	Height:	296 mm
EURO PALLET	Weight:	2895 gr	Weight:	2799 gr
	Bill units/pallet:	48	Bill units/pallet:	48
	Bill units/layer:	8	Bill units/layer:	8
CONTAINER PALLET HIGH CUBE	Layers/pallet:	6	Layers/pallet:	6
	Bill units/pallet:	112	Bill units/pallet:	112
	Bill units/layer:	16	Bill units/layer:	16
EAN BILL UNIT	Layers/pallet:	7	Layers/pallet:	7
				

VALUE GIFT PACKS





Cabernet Sauvignon







Pinot Noir



Champagne Glass



Riesling

ITEM	Item no.: fine crystal machine-made	6409/0	Item no.: fine crystal machine-made	6409/07	Item no.: fine crystal machine-made	6409/85	Item no.: fine crystal machine-made	6409/05
	Height/glass:	247 mm	Height/glass:	243 mm	Height/glass:	222 mm	Height/glass:	240 mm
	Capacity/glass:	800 ccm	Capacity/glass:	770 ccm	Capacity/glass:	305 ccm	Capacity/glass:	490 ccm
	Design:	2011	Design:	2011	Design:	2019	Design:	2011
PACKAGING	Pieces/Bill unit:	2	Pieces/Bill unit:	2	Pieces/Bill unit:	2	Pieces/Bill unit:	2
TYPE AND QUANTITY	Bill units/MP:	4	Bill units/MP:	4	Bill units/MP:	4	Bill units/MP:	4
BILL UNIT	Length:	263 mm	Length:	263 mm	Length:	263 mm	Length:	263 mm
DIMENSIONS	Width:	135 mm	Width:	135 mm	Width:	135 mm	Width:	135 mm
	Height:	279 mm	Height:	279 mm	Height:	279 mm	Height:	279 mm
	Weight:	710 gr	Weight:	710 gr	Weight:	634 gr	Weight:	658 gr
MASTERPACK	Length:	531 mm	Length:	531 mm	Length:	531 mm	Length:	531 mm
DIMENSIONS	Width:	278 mm	Width:	278 mm	Width:	278 mm	Width:	278 mm
	Height:	290 mm	Height:	290 mm	Height:	290 mm	Height:	290 mm
	Weight:	3262 gr	Weight:	3262 gr	Weight:	2958 gr	Weight:	3054 gr
EURO PALLET	Bill units/pallet:	144	Bill units/pallet:	144	Bill units/pallet:	144	Bill units/pallet:	144
	Bill units/layer:	24	Bill units/layer:	24	Bill units/layer:	24	Bill units/layer:	24
	Layers/pallet:	6	Layers/pallet:	6	Layers/pallet:	6	Layers/pallet:	6
CONTAINER PALLET	Bill units/pallet:	256	Bill units/pallet:	256	Bill units/pallet:	256	Bill units/pallet:	256
HIGH CUBE	Bill units/layer:	32	Bill units/layer:	32	Bill units/layer:	32	Bill units/layer:	32
	Layers/pallet:	8	Layers/pallet:	8	Layers/pallet:	8	Layers/pallet:	8
EAN	 9 006206 516346		 9 006206 516353		 9 006206 530601		 9 006206 516360	
BILL UNIT								





Oaked Chardonnay

ITEM	Item no.: 6409/97 fine crystal machine-made
	Height/glass: 227 mm Capacity/glass: 670 ccm Design: 2011
PACKAGING	Pieces/Bill unit: 2
TYPE AND QUANTITY	Bill units/MP: 4
BILL UNIT	Length: 263 mm
DIMENSIONS	Width: 135 mm Height: 279 mm Weight: 690 gr
MASTERPACK	Length: 531 mm
DIMENSIONS	Width: 278 mm Height: 290 mm Weight: 3812 gr
EURO PALLET	Bill units/pallet: 144 Bill units/layer: 24 Layers/pallet: 6
CONTAINER PALLET	Bill units/pallet: 256
HIGH CUBE	Bill units/layer: 32 Layers/pallet: 8
EAN BILL UNIT	 9 006206 516377



Cabernet Sauvignon
Pay 3 Get 4



Champagne Glass
Pay 3 Get 4

ITEM	Item no.: 5409/0 fine crystal machine-made	Item no.: 5409/85 fine crystal machine-made
	Height/glass: 247 mm Capacity/glass: 800 ccm Design: 2014	Height/glass: 222 mm Capacity/glass: 305 ccm Design: 2019
PACKAGING TYPE AND QUANTITY	Pieces/Bill unit: 4 Bill units/MP: 4	Pieces/Bill unit: 4 Bill units/MP: 4
BILL UNIT DIMENSIONS	Length: 519 mm Width: 134 mm Height: 279 mm Weight: 1382 gr	Length: 519 mm Width: 134 mm Height: 279 mm Weight: 926 gr
MASTERPACK DIMENSIONS	Length: 551 mm Width: 534 mm Height: 294 mm Weight: 6296 gr	Length: 551 mm Width: 534 mm Height: 294 mm Weight: 4126 gr
EURO PALLET	Bill units/pallet: 48 Bill units/layer: 16 Layers/pallet: 3	Bill units/pallet: 48 Bill units/layer: 16 Layers/pallet: 3
CONTAINER PALLET HIGH CUBE	Bill units/pallet: 112 Bill units/layer: 16 Layers/pallet: 7	Bill units/pallet: 112 Bill units/layer: 16 Layers/pallet: 7
EAN BILL UNIT	 9 006206 523573	 9 006206 529841





Riesling
Pay 3 Get 4

ITEM	Item no.: 5409/05 fine crystal machine-made Height/glass: 240 mm Capacity/glass: 490 ccm Design: 2014
PACKAGING TYPE AND QUANTITY	Pieces/Bill unit: 4 Bill units/MP: 4
BILL UNIT DIMENSIONS	Length: 519 mm Width: 134 mm Height: 279 mm Weight: 1278 gr
MASTERPACK DIMENSIONS	Length: 551 mm Width: 534 mm Height: 294 mm Weight: 5880 gr
EURO PALLET	Bill units/pallet: 48 Bill units/layer: 16 Layers/pallet: 3
CONTAINER PALLET HIGH CUBE	Bill units/pallet: 112 Bill units/layer: 16 Layers/pallet: 7
EAN BILL UNIT	

RIEDELBAAR

DRINK SPECIFIC GLASSWARE

RIEDEL DRINK SPECIFIC GLASSWARE (2019)

- DRINK SPECIFIC
- PERFECTLY ADJUSTED FOR ICE CUBES

All drinks can be traced back to 7 Classics. The Old Fashioned, Manhattan, Daiquiri, Sour, Peasant, Buck and Julep. With the 7 different glasses you will be able to make thousands of drinks based off those original 7 Classics. RIEDEL added an all purpose glass and a mixing glass to the collection to complete the range. Each glass was created with specific attention to size, shape, volume and capacity for ice.



MACHINE-MADE



All Purpose Glass*



Neat Glass*



Rocks Glass*



Double Rocks Glass*

ITEM	Item no.: 6417/0 fine crystal machine-made	Item no.: 6417/01 fine crystal machine-made	Item no.: 6417/02 fine crystal machine-made	Item no.: 6417/07 fine crystal machine-made
	Height/glass: 187 mm Capacity/glass: 350 ccm Design: 2019	Height/glass: 77 mm Capacity/glass: 174 ccm Design: 2019	Height/glass: 83 mm Capacity/glass: 283 ccm Design: 2019	Height/glass: 103 mm Capacity/glass: 370 ccm Design: 2022
PACKAGING	Pieces/Bill unit: 2	Pieces/Bill unit: 2	Pieces/Bill unit: 2	Pieces/Bill unit: 2
TYPE AND QUANTITY	Bill units/MP: 4	Bill units/MP: 4	Bill units/MP: 4	Bill units/MP: 4
BILL UNIT	Length: 166 mm	Length: 150 mm	Length: 173 mm	Length: 176 mm
DIMENSIONS	Width: 84 mm	Width: 74 mm	Width: 87 mm	Width: 88 mm
	Height: 197 mm	Height: 87 mm	Height: 93 mm	Height: 114 mm
	Weight: 347 gr	Weight: 509 gr	Weight: 687 gr	Weight: 842 gr
MASTERPACK	Length: 346 mm	Length: 307 mm	Length: 361 mm	Length: 358 mm
DIMENSIONS	Width: 173 mm	Width: 159 mm	Width: 189 mm	Width: 182 mm
	Height: 207 mm	Height: 104 mm	Height: 110 mm	Height: 126 mm
	Weight: 1541 gr	Weight: 2125 gr	Weight: 2865 gr	Weight: 3478 gr
EURO PALLET	Bill units/pallet: 432	Bill units/pallet: 748	Bill units/pallet: 480	Bill units/pallet: 528
	Bill units/layer: 48	Bill units/layer: 68	Bill units/layer: 48	Bill units/layer: 48
	Layers/pallet: 9	Layers/pallet: 11	Layers/pallet: 10	Layers/pallet: 11
CONTAINER PALLET	Bill units/pallet: 924	Bill units/pallet: 1092	Bill units/pallet: 780	Bill units/pallet: 660
HIGH CUBE	Bill units/layer: 84	Bill units/layer: 84	Bill units/layer: 60	Bill units/layer: 60
	Layers/pallet: 11	Layers/pallet: 13	Layers/pallet: 13	Layers/pallet: 11
EAN				
BILL UNIT	9 006206 529834	9 006206 529261	9 006206 529278	9 006206 323982



NEW



Highball Glass*



Fizz Glass*



Nick & Nora Glass*



Nick & Nora Glass Large

MACHINE-MADE

ITEM	Item no.: fine crystal machine-made	6417/04	Item no.: fine crystal machine-made	6417/03	Item no.: fine crystal machine-made	6417/05	Item no.: fine crystal machine-made	6417/08
	Height/glass:	154 mm	Height/glass:	163 mm	Height/glass:	153 mm	Height/glass:	177 mm
	Capacity/glass:	310 ccm	Capacity/glass:	265 ccm	Capacity/glass:	140 ccm	Capacity/glass:	198 ccm
	Design:	2019	Design:	2019	Design:	2019	Design:	2023
PACKAGING	Pieces/Bill unit:	2	Pieces/Bill unit:	2	Pieces/Bill unit:	2	Pieces/Bill unit:	2
TYPE AND QUANTITY	Bill units/MP:	4	Bill units/MP:	4	Bill units/MP:	4	Bill units/MP:	4
BILL UNIT	Length:	140 mm	Length:	128 mm	Length:	245 mm	Length:	227 mm
DIMENSIONS	Width:	67 mm	Width:	65 mm	Width:	120 mm	Width:	116 mm
	Height:	162 mm	Height:	172 mm	Height:	199 mm	Height:	224 mm
	Weight:	931 gr	Weight:	886 gr	Weight:	442 gr	Weight:	462 gr
MASTERPACK	Length:	294 mm	Length:	275 mm	Length:	491 mm	Length:	475 mm
DIMENSIONS	Width:	145 mm	Width:	143 mm	Width:	256 mm	Width:	232 mm
	Height:	180 mm	Height:	185 mm	Height:	210 mm	Height:	240 mm
	Weight:	3833 gr	Weight:	3644 gr	Weight:	2038 gr	Weight:	2080 gr
EURO PALLET	Bill units/pallet:	480	Bill units/pallet:	480	Bill units/pallet:	192	Bill units/pallet:	196
	Bill units/layer:	80	Bill units/layer:	80	Bill units/layer:	24	Bill units/layer:	28
	Layers/pallet:	6	Layers/pallet:	6	Layers/pallet:	8	Layers/pallet:	7
CONTAINER PALLET	Bill units/pallet:	560	Bill units/pallet:	560	Bill units/pallet:	320	Bill units/pallet:	360
HIGH CUBE	Bill units/layer:	112	Bill units/layer:	112	Bill units/layer:	32	Bill units/layer:	40
	Layers/pallet:	5	Layers/pallet:	5	Layers/pallet:	10	Layers/pallet:	9
EAN								
BILL UNIT	9 006206 529292		9 006206 529285		9 006206 529308		9 006206 325832	



RIEDEL DRINK SPECIFIC GLASSWARE MOVIE





Sour Glass*



Sour Glass Optic



Coffee Glass



Mixing Glass*

ITEM	Item no.: fine crystal machine-made	6417/06	Item no.: fine crystal machine-made	6417/09	Item no.: fine crystal machine-made	6417/10	Item no.: fine crystal machine-made	6417/23
	Height/glass:	158 mm	Height/glass:	158 mm	Height/glass:	63 mm	Height/glass:	176 mm
	Capacity/glass:	217 ccm	Capacity/glass:	217 ccm	Capacity/glass:	90 ccm	Capacity/glass:	650 ccm
	Design:	2019	Design:	2023	Design:	2023	Design:	2019
PACKAGING	Pieces/Bill unit:	2	Pieces/Bill unit:	2	Pieces/Bill unit:	2	Pieces/Bill unit:	1
TYPE AND QUANTITY	Bill units/MP:	4	Bill units/MP:	4	Bill units/MP:	4	Bill units/MP:	4
BILL UNIT	Length:	245 mm	Length:	227 mm	Length:	140 mm	Length:	92 mm
DIMENSIONS	Width:	120 mm	Width:	116 mm	Width:	70 mm	Width:	92 mm
	Height:	199 mm	Height:	224 mm	Height:	82 mm	Height:	189 mm
	Weight:	492 gr	Weight:	472 gr	Weight:	282 gr	Weight:	884 gr
MASTERPACK	Length:	491 mm	Length:	475 mm	Length:	148 mm	Length:	199 mm
DIMENSIONS	Width:	256 mm	Width:	232 mm	Width:	148 mm	Width:	199 mm
	Height:	210 mm	Height:	240 mm	Height:	172 mm	Height:	204 mm
	Weight:	2238 gr	Weight:	2120 gr	Weight:	1194 gr	Weight:	3651 gr
EURO PALLET	Bill units/pallet:	192	Bill units/pallet:	196	Bill units/pallet:	1400	Bill units/pallet:	480
	Bill units/layer:	24	Bill units/layer:	28	Bill units/layer:	140	Bill units/layer:	96
	Layers/pallet:	8	Layers/pallet:	7	Layers/pallet:	10	Layers/pallet:	5
CONTAINER PALLET	Bill units/pallet:	320	Bill units/pallet:	360	Bill units/pallet:	1792	Bill units/pallet:	600
HIGH CUBE	Bill units/layer:	32	Bill units/layer:	40	Bill units/layer:	224	Bill units/layer:	120
	Layers/pallet:	10	Layers/pallet:	9	Layers/pallet:	98	Layers/pallet:	5
EAN								
BILL UNIT	9 006206 529315		9 006206 325894		9 006206 326099		9 006206 530397	





Rocks & Highball Set*

ITEM	Item no.: 5417/57 fine crystal machine-made
	Height/glass: - Capacity/glass: - Design: 2022
PACKAGING	Pieces/Bill unit: 8
TYPE AND QUANTITY	Bill units/MP: 2
BILL UNIT	Length: 174 mm
DIMENSIONS	Width: 174 mm
	Height: 236 mm
	Weight: 3319 gr
MASTERPACK	Length: 367 mm
DIMENSIONS	Width: 193 mm
	Height: 263 mm
	Weight: 6908 gr
EURO PALLET	Bill units/pallet: 144
	Bill units/layer: 24
	Layers/pallet: 6
CONTAINER PALLET	Bill units/pallet: 150
HIGH CUBE	Bill units/layer: 30
	Layers/pallet: 5
EAN	 9 006206 323470
BILL UNIT	



MACHINE-MADE

**RIEDEL WINE FRIENDLY (2022)
GLASSES FOR BEGINNERS OR
OCCASIONAL WINE DRINKERS**

Instead of being functional and matched to the grape variety, the glasses of the RIEDEL WINE FRIENDLY collection are designed for a specific purpose. With this collection, RIEDEL is responding to a worldwide increase in demand for "easy to use" entry-level glasses. The collection was originally developed as a mise-en-place for the restaurant industry, where universal glasses are preferred due to limited storage space.



Magnum



Red Wine

ITEM	Item no.:	6422/01-4	Item no.:	6422/02-4
	fine crystal machine-made		fine crystal machine-made	
	Height/glass:	261 mm	Height/glass:	247 mm
	Capacity/glass:	995 ccm	Capacity/glass:	667 ccm
PACKAGING TYPE AND QUANTITY	Design:	2022	Design:	2022
	Pieces/Bill unit:	4	Pieces/Bill unit:	4
BILL UNIT DIMENSIONS	Bill units/MP:	2	Bill units/MP:	2
	Length:	226 mm	Length:	204 mm
	Width:	226 mm	Width:	204 mm
	Height:	271 mm	Height:	251 mm
MASTERPACK DIMENSIONS	Weight:	1190 gr	Weight:	937 gr
	Length:	463 mm	Length:	413 mm
	Width:	237 mm	Width:	219 mm
	Height:	282 mm	Height:	270 mm
EURO PALLET	Weight:	2661 gr	Weight:	2092 gr
	Bill units/pallet:	84	Bill units/pallet:	98
	Bill units/layer:	14	Bill units/layer:	14
CONTAINER PALLET HIGH CUBE	Layers/pallet:	6	Layers/pallet:	7
	Bill units/pallet:	160	Bill units/pallet:	192
	Bill units/layer:	20	Bill units/layer:	24
EAN BILL UNIT	Layers/pallet:	8	Layers/pallet:	8
		 9 006206 323869		 9 006206 323883





White Wine/Champagne Wine Glass



Tumbler

ITEM	Item no.: 6422/03-4 fine crystal machine-made Height/glass: 221 mm Capacity/glass: 440 ccm Design: 2022	Item no.: 6422/04-4 fine crystal machine-made Height/glass: 118 mm Capacity/glass: 570 ccm Design: 2022
PACKAGING TYPE AND QUANTITY	Pieces/Bill unit: 4 Bill units/MP: 4	Pieces/Bill unit: 4 Bill units/MP: 2
BILL UNIT DIMENSIONS	Length: 173 mm Width: 171 mm Height: 230 mm Weight: 790 gr	Length: 197 mm Width: 197 mm Height: 124 mm Weight: 591 gr
MASTERPACK DIMENSIONS	Length: 366 mm Width: 366 mm Height: 244 mm Weight: 3458 gr	Length: 412 mm Width: 214 mm Height: 145 mm Weight: 1343 gr
EURO PALLET	Bill units/pallet: 168 Bill units/layer: 24 Layers/pallet: 7	Bill units/pallet: 182 Bill units/layer: 14 Layers/pallet: 13
CONTAINER PALLET HIGH CUBE	Bill units/pallet: 216 Bill units/layer: 24 Layers/pallet: 9	Bill units/pallet: 384 Bill units/layer: 24 Layers/pallet: 16
EAN BILL UNIT	 9 006206 323890	 9 006206 323906





Decanter RIEDEL Wine Friendly

ITEM	Item no.:	1422/03	
	fine crystal		
	machine-made		
	Height/glass:	285 mm	
PACKAGING	Pieces/Bill unit:	1	
	TYPE AND QUANTITY	Bill units/MP: 4	
	BILL UNIT		
DIMENSIONS	Length:	115 mm	
	Width:	115 mm	
	Height:	306 mm	
	Weight:	461 gr	
MASTERPACK	Length:	239 mm	
	DIMENSIONS	Width:	239 mm
	Height:	317 mm	
	Weight:	2016 gr	
EURO PALLET	Bill units/pallet:	240	
	Bill units/layer:	48	
	Layers/pallet:	5	
CONTAINER PALLET	Bill units/pallet:	560	
	HIGH CUBE	Bill units/layer:	80
	Layers/pallet:	7	
EAN			
BILL UNIT			



RIEDEL

THE SPIRIT GLASS COMPANY



RIEDEL TUMBLER COLLECTION (2018) TRENDY URBAN BAR TUMBLER

The perfect 'must have' glasses for all cocktails and mixed drinks. With four different designs, inspired by the glamorous Art Nouveau period, these elegant, decorated crystal tumblers present a contrast to RIEDEL'S purist, unadorned wine glasses. Spirits and cocktail connoisseurs will enjoy discovering the versatility of these stylish, yet subtly nostalgic, glasses for the enjoyment of Whiskies, Gin and Tonic, Cocktails and mixed drinks alike.



Optical „O“
Whisky



Optical „O“
Longdrink



RIEDEL Spey
Single Old Fashioned



RIEDEL Spey
Whisky

ITEM	Item no.: fine crystal machine-made	0515/05	Item no.: fine crystal machine-made	0515/90	Item no.: fine crystal machine-made	0515/01S3	Item no.: fine crystal machine-made	0515/02S3
	Height/glass:	96 mm	Height/glass:	113 mm	Height/glass:	80 mm	Height/glass:	102 mm
	Capacity/glass:	344 ccm	Capacity/glass:	580 ccm	Capacity/glass:	245 ccm	Capacity/glass:	295 ccm
	Design:	2018	Design:	2018	Design:	2022	Design:	2018
PACKAGING	Pieces/Bill unit:	2	Pieces/Bill unit:	2	Pieces/Bill unit:	2	Pieces/Bill unit:	2
TYPE AND QUANTITY	Bill units/MP:	4	Bill units/MP:	4	Bill units/MP:	4	Bill units/MP:	4
BILL UNIT	Length:	169 mm	Length:	201 mm	Length:	168 mm	Length:	174 mm
DIMENSIONS	Width:	85 mm	Width:	101 mm	Width:	86 mm	Width:	88 mm
	Height:	106 mm	Height:	131 mm	Height:	92 mm	Height:	109 mm
	Weight:	276 gr	Weight:	344 gr	Weight:	662 gr	Weight:	862 gr
MASTERPACK	Length:	221 mm	Length:	271 mm	Length:	178 mm	Length:	371 mm
DIMENSIONS	Width:	179 mm	Width:	211 mm	Width:	354 mm	Width:	192 mm
	Height:	180 mm	Height:	212 mm	Height:	103 mm	Height:	144 mm
	Weight:	1244 gr	Weight:	1556 gr	Weight:	2749 gr	Weight:	3668 gr
EURO PALLET	Bill units/pallet:	960	Bill units/pallet:	540	Bill units/pallet:	720	Bill units/pallet:	480
	Bill units/layer:	96	Bill units/layer:	60	Bill units/layer:	48	Bill units/layer:	48
	Layers/pallet:	10	Layers/pallet:	9	Layers/pallet:	15	Layers/pallet:	10
CONTAINER PALLET	Bill units/pallet:	1560	Bill units/pallet:	924	Bill units/pallet:	840	Bill units/pallet:	600
HIGH CUBE	Bill units/layer:	120	Bill units/layer:	84	Bill units/layer:	60	Bill units/layer:	60
	Layers/pallet:	13	Layers/pallet:	11	Layers/pallet:	14	Layers/pallet:	10
EAN								
BILL UNIT	9 006206 527441		9 006206 527434		9 006206 324033		9 006206 527632	





RIEDEL Spey
Longdrink







RIEDEL Shadows
Tumbler



RIEDEL Fire
Whisky



RIEDEL Fire
Longdrink



ITEM	Item no.: 0515/0453 fine crystal machine-made	Item no.: 0515/0255 fine crystal machine-made	Item no.: 0515/0251 fine crystal machine-made	Item no.: 0515/0451 fine crystal machine-made
	Height/glass: 151 mm Capacity/glass: 395 ccm Design: 2018	Height/glass: 102 mm Capacity/glass: 323 ccm Design: 2019	Height/glass: 98 mm Capacity/glass: 295 ccm Design: 2018	Height/glass: 151 mm Capacity/glass: 375 ccm Design: 2018
PACKAGING TYPE AND QUANTITY	Pieces/Bill unit: 2 Bill units/MP: 4	Pieces/Bill unit: 2 Bill units/MP: 4	Pieces/Bill unit: 2 Bill units/MP: 4	Pieces/Bill unit: 2 Bill units/MP: 4
BILL UNIT DIMENSIONS	Length: 167 mm Width: 83 mm Height: 162 mm Weight: 1084 gr	Length: 174 mm Width: 88 mm Height: 111 mm Weight: 823 gr	Length: 174 mm Width: 88 mm Height: 109 mm Weight: 662 gr	Length: 167 mm Width: 83 mm Height: 162 mm Weight: 952 gr
MASTERPACK DIMENSIONS	Length: 361 mm Width: 185 mm Height: 194 mm Weight: 4583 gr	Length: 359 mm Width: 186 mm Height: 126 mm Weight: 3408 gr	Length: 371 mm Width: 192 mm Height: 144 mm Weight: 2851 gr	Length: 351 mm Width: 180 mm Height: 176 mm Weight: 3937 gr
EURO PALLET	Bill units/pallet: 384 Bill units/layer: 48 Layers/pallet: 8	Bill units/pallet: 576 Bill units/layer: 48 Layers/pallet: 12	Bill units/pallet: 624 Bill units/layer: 48 Layers/pallet: 13	Bill units/pallet: 432 Bill units/layer: 48 Layers/pallet: 9
CONTAINER PALLET HIGH CUBE	Bill units/pallet: 480 Bill units/layer: 60 Layers/pallet: 8	Bill units/pallet: 660 Bill units/layer: 60 Layers/pallet: 11	Bill units/pallet: 780 Bill units/layer: 60 Layers/pallet: 13	Bill units/pallet: 576 Bill units/layer: 72 Layers/pallet: 8
EAN BILL UNIT	 9 006206 527663	 9 006206 530144	 9 006206 527618	 9 006206 527649



Optical „O“
All Purpose Glass



RIEDEL Fire & Ice

ITEM	Item no.: 0515/67 fine crystal machine-made Height/glass: 124 mm Capacity/glass: 762 ccm Design: 2019	Item no.: 5515/4451 fine crystal machine-made Height/glass: 98 mm Capacity/glass: 295 ccm Design: 2019
PACKAGING TYPE AND QUANTITY	Pieces/Bill unit: 2 Bill units/MP: 4	Pieces/Bill unit: 4 Bill units/MP: 2
BILL UNIT DIMENSIONS	Length: 227 mm Width: 114 mm Height: 133 mm Weight: 350 gr	Length: 172 mm Width: 172 mm Height: 110 mm Weight: 1312 gr
MASTERPACK DIMENSIONS	Length: 458 mm Width: 235 mm Height: 146 mm Weight: 1640 gr	Length: 354 mm Width: 183 mm Height: 124 mm Weight: 2748 gr
EURO PALLET	Bill units/pallet: 416 Bill units/layer: 104 Layers/pallet: 4	Bill units/pallet: 264 Bill units/layer: 24 Layers/pallet: 11
CONTAINER PALLET HIGH CUBE	Bill units/pallet: 720 Bill units/layer: 144 Layers/pallet: 5	Bill units/pallet: 324 Bill units/layer: 36 Layers/pallet: 9
EAN BILL UNIT	 9 006206 530045	 9 006206 530120



overture

A still life composition featuring a glass of red wine, a wooden cheese board with cheese, grapes, and bread, and a loaf of bread on a rustic wooden surface.

OUVERTURE (1989) RIEDEL'S ENTRY LEVEL

OUVERTURE is RIEDEL's entry level series for customers who appreciate good, reasonably priced wine. OUVERTURE is a non-varietal specific collection, of fine crystal glasses, that will increase the owner's drinking pleasure of wine, beer and spirits.





Magnum



Red Wine



Champagne Glass



White Wine

ITEM	Item no.: 6408/90 fine crystal machine-made	Item no.: 6408/00 fine crystal machine-made	Item no.: 6408/48 fine crystal machine-made	Item no.: 6408/05 fine crystal machine-made
	Height/glass: 201 mm Capacity/glass: 530 ccm Design: 1997	Height/glass: 187 mm Capacity/glass: 350 ccm Design: 1989	Height/glass: 217 mm Capacity/glass: 260 ccm Design: 1997	Height/glass: 180 mm Capacity/glass: 280 ccm Design: 1990
PACKAGING TYPE AND QUANTITY	Pieces/Bill unit: 2 Bill units/MP: 4	Pieces/Bill unit: 2 Bill units/MP: 4	Pieces/Bill unit: 2 Bill units/MP: 4	Pieces/Bill unit: 2 Bill units/MP: 4
BILL UNIT DIMENSIONS	Length: 189 mm Width: 95 mm Height: 211 mm Weight: 440 gr	Length: 166 mm Width: 84 mm Height: 197 mm Weight: 347 gr	Length: 147 mm Width: 74 mm Height: 227 mm Weight: 316 gr	Length: 154 mm Width: 78 mm Height: 191 mm Weight: 299 gr
MASTERPACK DIMENSIONS	Length: 390 mm Width: 196 mm Height: 221 mm Weight: 1970 gr	Length: 346 mm Width: 173 mm Height: 207 mm Weight: 1541 gr	Length: 306 mm Width: 154 mm Height: 237 mm Weight: 1396 gr	Length: 326 mm Width: 161 mm Height: 201 mm Weight: 1338 gr
EURO PALLET	Bill units/pallet: 384 Bill units/layer: 48 Layers/pallet: 8	Bill units/pallet: 432 Bill units/layer: 48 Layers/pallet: 9	Bill units/pallet: 544 Bill units/layer: 68 Layers/pallet: 8	Bill units/pallet: 504 Bill units/layer: 56 Layers/pallet: 9
CONTAINER PALLET HIGH CUBE	Bill units/pallet: 600 Bill units/layer: 60 Layers/pallet: 10	Bill units/pallet: 924 Bill units/layer: 84 Layers/pallet: 11	Bill units/pallet: 960 Bill units/layer: 64 Layers/pallet: 15	Bill units/pallet: 924 Bill units/layer: 84 Layers/pallet: 11
EAN BILL UNIT				







Ouverture + Gift
6x Magnum + 1x RIEDEL Apple Decanter



Ouverture White Wine / Magnum / Champagne Glass
Value Gift Pack - Pay 9 Get 12

ITEM	Item no.: 5408/35 fine crystal machine-made	Item no.: 5408/93 fine crystal machine-made
	Height/glass: - Capacity/glass: - Design: 2015	Height/glass: - Capacity/glass: - Design: 2017
PACKAGING	Pieces/Bill unit: 7	Pieces/Bill unit: 12
TYPE AND QUANTITY	Bill units/MP: 1	Bill units/MP: 1
BILL UNIT	Length: 475 mm	Length: 436 mm
DIMENSIONS	Width: 228 mm	Width: 335 mm
	Height: 245 mm	Height: 250 mm
	Weight: 2070 gr	Weight: 2631 gr
MASTERPACK	Length: 484 mm	Length: 446 mm
DIMENSIONS	Width: 237 mm	Width: 345 mm
	Height: 254 mm	Height: 263 mm
	Weight: 2260 gr	Weight: 3010 gr
EURO PALLET	Bill units/pallet: 49	Bill units/pallet: 35
	Bill units/layer: 7	Bill units/layer: 5
	Layers/pallet: 7	Layers/pallet: 7
CONTAINER PALLET	Bill units/pallet: 90	Bill units/pallet: 56
HIGH CUBE	Bill units/layer: 10	Bill units/layer: 7
	Layers/pallet: 9	Layers/pallet: 8
EAN	 9 006206 524389	 9 006206 526079
BILL UNIT		





SL

RIEDEL STEMLESS WINGS



MACHINE-MADE

Riedel

SL RIEDEL STEMLESS WINGS (2021)

- COMPLEMENT TO THE ORIGINAL STEMMED SERIES
- PERFECTLY CRADELED THANKS TO ITS UNIQUE CURVATURE

This stemless creation is the perfect complement to the original stemmed series RIEDEL Winewings, crafted by Georg Riedel. These shapes have been redesigned to ensure they sit comfortably within the drinker's hand.

As a result, each grape varietal shape required a set of new handmade prototypes and molds to determine how much the size of the glass could be reduced while maintaining the delicate and important characteristics of each wine.



Cabernet/Merlot



Pinot Noir/Nebbiolo



Riesling/Sauvignon/Champagne Glass



RIEDEL SL Wings To Fly
Cabernet/Merlot

ITEM	Item no.: fine crystal machine-made	6789/0	Item no.: fine crystal machine-made	6789/07	Item no.: fine crystal machine-made	6789/15	Item no.: fine crystal machine-made	2789/0
	Height/glass:	121 mm	Height/glass:	121 mm	Height/glass:	109 mm	Height/glass:	121 mm
	Capacity/glass:	675 ccm	Capacity/glass:	630 ccm	Capacity/glass:	440 ccm	Capacity/glass:	675 ccm
	Design:	2021	Design:	2021	Design:	2021	Design:	2021
PACKAGING	Pieces/Bill unit:	2	Pieces/Bill unit:	2	Pieces/Bill unit:	2	Pieces/Bill unit:	1
TYPE AND QUANTITY	Bill units/MP:	4	Bill units/MP:	4	Bill units/MP:	4	Bill units/MP:	4
BILL UNIT	Length:	212 mm	Length:	212 mm	Length:	192 mm	Length:	107 mm
DIMENSIONS	Width:	108 mm	Width:	108 mm	Width:	98 mm	Width:	107 mm
	Height:	132 mm	Height:	132 mm	Height:	119 mm	Height:	137 mm
	Weight:	328 gr	Weight:	328 gr	Weight:	274 gr	Weight:	237 gr
MASTERPACK	Length:	442 mm	Length:	442 mm	Length:	400 mm	Length:	224 mm
DIMENSIONS	Width:	222 mm	Width:	222 mm	Width:	200 mm	Width:	224 mm
	Height:	147 mm	Height:	147 mm	Height:	135 mm	Height:	152 mm
	Weight:	1480 gr	Weight:	1480 gr	Weight:	1239 gr	Weight:	1078 gr
EURO PALLET	Bill units/pallet:	336	Bill units/pallet:	336	Bill units/pallet:	364	Bill units/pallet:	720
	Bill units/layer:	28	Bill units/layer:	28	Bill units/layer:	28	Bill units/layer:	60
	Layers/pallet:	12	Layers/pallet:	12	Layers/pallet:	13	Layers/pallet:	12
CONTAINER PALLET	Bill units/pallet:	600	Bill units/pallet:	600	Bill units/pallet:	960	Bill units/pallet:	1120
HIGH CUBE	Bill units/layer:	40	Bill units/layer:	40	Bill units/layer:	60	Bill units/layer:	80
	Layers/pallet:	15	Layers/pallet:	15	Layers/pallet:	16	Layers/pallet:	14
EAN								
BILL UNIT	9 006206 322046		9 006206 322053		9 006206 322060		9 006206 322282	





RIEDEL SL Wings To Fly
Pinot Noir/Nebbiolo





RIEDEL SL Wings To Fly
Riesling/Champagne Glass



Cabernet/Merlot + Decanter

MACHINE-MADE

ITEM	Item no.: 2789/07 fine crystal machine-made Height/glass: 121 mm Capacity/glass: 630 ccm Design: 2021	Item no.: 2789/15 fine crystal machine-made Height/glass: 109 mm Capacity/glass: 440 ccm Design: 2021	Item no.: 5789/30 fine crystal machine-made Height/glass: - Capacity/glass: - Design: 2021
PACKAGING TYPE AND QUANTITY	Pieces/Bill unit: 1 Bill units/MP: 4	Pieces/Bill unit: 1 Bill units/MP: 4	Pieces/Bill unit: 5 Bill units/MP: 2
BILL UNIT DIMENSIONS	Length: 107 mm Width: 107 mm Height: 137 mm Weight: 237 gr	Length: 104 mm Width: 104 mm Height: 130 mm Weight: 205 gr	Length: 241 mm Width: 223 mm Height: 275 mm Weight: 1214 gr
MASTERPACK DIMENSIONS	Length: 224 mm Width: 224 mm Height: 152 mm Weight: 1078 gr	Length: 219 mm Width: 219 mm Height: 144 mm Weight: 930 gr	Length: 456 mm Width: 250 mm Height: 300 mm Weight: 2678 gr
EURO PALLET	Bill units/pallet: 720 Bill units/layer: 60 Layers/pallet: 12	Bill units/pallet: 780 Bill units/layer: 60 Layers/pallet: 13	Bill units/pallet: 84 Bill units/layer: 14 Layers/pallet: 6
CONTAINER PALLET HIGH CUBE	Bill units/pallet: 1120 Bill units/layer: 80 Layers/pallet: 14	Bill units/pallet: 1280 Bill units/layer: 80 Layers/pallet: 16	Bill units/pallet: 140 Bill units/layer: 20 Layers/pallet: 7
EAN BILL UNIT	 9 006206 322299	 9 006206 322305	 9 006206 322152



THE **O** WINE TUMBLER

O THE WINE TUMBLER (2004) FOR EVERY DAY WINE ENJOYMENT THE ORIGINAL STEMLESS WINE TUMBLER

O THE WINE TUMBLER is the first varietal specific wine tumbler in history. **O** is an innovative take on the casual wine glass, giving total wine enjoyment. **O** is based on the benchmark shapes of VINUM to enhance the world's most important grape varietals. The tumbler, used for centuries as an all-round drinking vessel, is now turned into a sophisticated wine accessory. Broken stems are a thing of the past.





Syrah/Shiraz



New World Pinot Noir



Old World Syrah



Champagne Glass

ITEM	Item no.: fine crystal machine-made	0414/30	Item no.: fine crystal machine-made	0414/67	Item no.: fine crystal machine-made	0414/41	Item no.: fine crystal machine-made	0414/28
	Height/glass:	132 mm	Height/glass:	124 mm	Height/glass:	118 mm	Height/glass:	122 mm
	Capacity/glass:	620 ccm	Capacity/glass:	762 ccm	Capacity/glass:	570 ccm	Capacity/glass:	264 ccm
	Design:	2003	Design:	2014	Design:	2014	Design:	2014
PACKAGING	Pieces/Bill unit:	2	Pieces/Bill unit:	2	Pieces/Bill unit:	2	Pieces/Bill unit:	2
TYPE AND QUANTITY	Bill units/MP:	4	Bill units/MP:	4	Bill units/MP:	4	Bill units/MP:	4
BILL UNIT	Length:	201 mm	Length:	227 mm	Length:	202 mm	Length:	137 mm
DIMENSIONS	Width:	101 mm	Width:	114 mm	Width:	125 mm	Width:	69 mm
	Height:	142 mm	Height:	133 mm	Height:	100 mm	Height:	132 mm
	Weight:	329 gr	Weight:	350 gr	Weight:	300 gr	Weight:	253 gr
MASTERPACK	Length:	293 mm	Length:	458 mm	Length:	413 mm	Length:	272 mm
DIMENSIONS	Width:	211 mm	Width:	235 mm	Width:	210 mm	Width:	142 mm
	Height:	212 mm	Height:	146 mm	Height:	139 mm	Height:	143 mm
	Weight:	1478 gr	Weight:	1640 gr	Weight:	1430 gr	Weight:	1322 gr
EURO PALLET	Bill units/pallet:	504	Bill units/pallet:	416	Bill units/pallet:	496	Bill units/pallet:	1040
	Bill units/layer:	56	Bill units/layer:	104	Bill units/layer:	124	Bill units/layer:	80
	Layers/pallet:	9	Layers/pallet:	4	Layers/pallet:	4	Layers/pallet:	13
CONTAINER PALLET	Bill units/pallet:	880	Bill units/pallet:	720	Bill units/pallet:	840	Bill units/pallet:	1680
HIGH CUBE	Bill units/layer:	80	Bill units/layer:	144	Bill units/layer:	168	Bill units/layer:	112
	Layers/pallet:	11	Layers/pallet:	5	Layers/pallet:	5	Layers/pallet:	15
EAN								
BILL UNIT	9 006206 512157		9 006206 522576		9 006206 522590		9 006206 522538	





Cabernet/Merlot



Pinot Noir/Nebbiolo



O To Go
Red Wine



Riesling/Sauvignon Blanc

MACHINE-MADE

ITEM	Item no.: 0414/0 fine crystal machine-made	Item no.: 0414/07 fine crystal machine-made	Item no.: 2414/41 fine crystal machine-made	Item no.: 0414/15 fine crystal machine-made
	Height/glass: 121 mm Capacity/glass: 620 ccm Design: 2003	Height/glass: 110 mm Capacity/glass: 690 ccm Design: 2003	Height/glass: 118 mm Capacity/glass: 570 ccm Design: 2014	Height/glass: 108 mm Capacity/glass: 375 ccm Design: 2003
PACKAGING TYPE AND QUANTITY	Pieces/Bill unit: 2 Bill units/MP: 4	Pieces/Bill unit: 2 Bill units/MP: 4	Pieces/Bill unit: 1 Bill units/MP: 4	Pieces/Bill unit: 2 Bill units/MP: 4
BILL UNIT DIMENSIONS	Length: 201 mm Width: 101 mm Height: 131 mm Weight: 300 gr	Length: 226 mm Width: 113 mm Height: 120 mm Weight: 305 gr	Length: 104 mm Width: 104 mm Height: 141 mm Weight: 225 gr	Length: 169 mm Width: 85 mm Height: 118 mm Weight: 266 gr
MASTERPACK DIMENSIONS	Length: 271 mm Width: 211 mm Height: 212 mm Weight: 1380 gr	Length: 249 mm Width: 236 mm Height: 237 mm Weight: 1395 gr	Length: 220 mm Width: 220 mm Height: 150 mm Weight: 1003 gr	Length: 245 mm Width: 179 mm Height: 180 mm Weight: 1166 gr
EURO PALLET	Bill units/pallet: 540 Bill units/layer: 60 Layers/pallet: 9	Bill units/pallet: 480 Bill units/layer: 60 Layers/pallet: 8	Bill units/pallet: 832 Bill units/layer: 104 Layers/pallet: 8	Bill units/pallet: 800 Bill units/layer: 80 Layers/pallet: 10
CONTAINER PALLET HIGH CUBE	Bill units/pallet: 924 Bill units/layer: 84 Layers/pallet: 11	Bill units/pallet: 720 Bill units/layer: 80 Layers/pallet: 9	Bill units/pallet: 1480 Bill units/layer: 148 Layers/pallet: 10	Bill units/pallet: 1344 Bill units/layer: 112 Layers/pallet: 12
EAN BILL UNIT				



O WINE TUMBLER MOVIE





O To Go
White Wine



Viognier/Chardonnay



Oaked Chardonnay



Spirits/Fortified Wines/
Cask Aged Brandies

ITEM	Item no.: fine crystal machine-made	2414/22	Item no.: fine crystal machine-made	0414/05	Item no.: fine crystal machine-made	0414/97	Item no.: fine crystal machine-made	0414/60
	Height/glass:	105 mm	Height/glass:	96 mm	Height/glass:	94 mm	Height/glass:	90 mm
	Capacity/glass:	375 ccm	Capacity/glass:	320 ccm	Capacity/glass:	580 ccm	Capacity/glass:	235 ccm
	Design:	2014	Design:	2003	Design:	2003	Design:	2004
PACKAGING	Pieces/Bill unit:	1	Pieces/Bill unit:	2	Pieces/Bill unit:	2	Pieces/Bill unit:	2
TYPE AND QUANTITY	Bill units/MP:	4	Bill units/MP:	4	Bill units/MP:	4	Bill units/MP:	4
BILL UNIT	Length:	88 mm	Length:	169 mm	Length:	226 mm	Length:	144 mm
DIMENSIONS	Width:	88 mm	Width:	85 mm	Width:	113 mm	Width:	73 mm
	Height:	124 mm	Height:	106 mm	Height:	102 mm	Height:	98 mm
	Weight:	198 gr	Weight:	240 gr	Weight:	290 gr	Weight:	228 gr
MASTERPACK	Length:	183 mm	Length:	221 mm	Length:	236 mm	Length:	301 mm
DIMENSIONS	Width:	183 mm	Width:	179 mm	Width:	214 mm	Width:	155 mm
	Height:	131 mm	Height:	180 mm	Height:	237 mm	Height:	115 mm
	Weight:	869 gr	Weight:	1100 gr	Weight:	1310 gr	Weight:	995 gr
EURO PALLET	Bill units/pallet:	1520	Bill units/pallet:	960	Bill units/pallet:	480	Bill units/pallet:	1088
	Bill units/layer:	152	Bill units/layer:	96	Bill units/layer:	60	Bill units/layer:	68
	Layers/pallet:	10	Layers/pallet:	10	Layers/pallet:	8	Layers/pallet:	16
CONTAINER PALLET	Bill units/pallet:	2496	Bill units/pallet:	1560	Bill units/pallet:	900	Bill units/pallet:	2080
HIGH CUBE	Bill units/layer:	208	Bill units/layer:	120	Bill units/layer:	100	Bill units/layer:	104
	Layers/pallet:	12	Layers/pallet:	13	Layers/pallet:	9	Layers/pallet:	20
EAN								
BILL UNIT	9 006206 523184		9 006206 512188		9 006206 512171		9 006206 512584	







Whisky



Water

ITEM	Item no.: 0414/02 fine crystal machine-made	Item no.: 0414/01 fine crystal machine-made
	Height/glass: 100 mm	Height/glass: 80 mm
	Capacity/glass: 430 ccm	Capacity/glass: 330 ccm
	Design: 2005	Design: 2005
PACKAGING TYPE AND QUANTITY	Pieces/Bill unit: 2	Pieces/Bill unit: 2
	Bill units/MP: 4	Bill units/MP: 4
BILL UNIT DIMENSIONS	Length: 176 mm	Length: 176 mm
	Width: 89 mm	Width: 89 mm
	Height: 112 mm	Height: 92 mm
	Weight: 303 gr	Weight: 276 gr
MASTERPACK DIMENSIONS	Length: 418 mm	Length: 189 mm
	Width: 233 mm	Width: 187 mm
	Height: 157 mm	Height: 190 mm
	Weight: 1528 gr	Weight: 1211 gr
EURO PALLET	Bill units/pallet: 252	Bill units/pallet: 960
	Bill units/layer: 28	Bill units/layer: 96
	Layers/pallet: 9	Layers/pallet: 10
CONTAINER PALLET HIGH CUBE	Bill units/pallet: 672	Bill units/pallet: 1440
	Bill units/layer: 48	Bill units/layer: 120
	Layers/pallet: 14	Layers/pallet: 12
EAN BILL UNIT	 9 006206 513116	 9 006206 513109



Happy „O“



Happy „O“ Vol. 2

ITEM	Item no.:	5414/44	Item no.:	5414/88
	fine crystal machine-made		fine crystal machine-made	
	Height/glass:	96 mm	Height/glass:	96 mm
	Capacity/glass:	320 ccm	Capacity/glass:	320 ccm
PACKAGING TYPE AND QUANTITY	Design:	2007	Design:	2017
	Pieces/Bill unit:	4	Pieces/Bill unit:	4
BILL UNIT DIMENSIONS	Bill units/MP:	4	Bill units/MP:	4
	Length:	163 mm	Length:	163 mm
	Width:	163 mm	Width:	163 mm
	Height:	105 mm	Height:	105 mm
MASTERPACK DIMENSIONS	Weight:	483 gr	Weight:	483 gr
	Length:	339 mm	Length:	339 mm
	Width:	175 mm	Width:	175 mm
	Height:	222 mm	Height:	222 mm
EURO PALLET	Weight:	2099 gr	Weight:	2099 gr
	Bill units/pallet:	448	Bill units/pallet:	448
	Bill units/layer:	56	Bill units/layer:	56
CONTAINER PALLET HIGH CUBE	Layers/pallet:	8	Layers/pallet:	8
	Bill units/pallet:	840	Bill units/pallet:	840
	Bill units/layer:	84	Bill units/layer:	84
EAN BILL UNIT	Layers/pallet:	10	Layers/pallet:	10
		 9 006206 514328		 9 006206 525904





Happy „O“ Optic

ITEM	Item no.: 5515/44 fine crystal machine-made Height/glass: 96 mm Capacity/glass: 344 ccm Design: 2019
PACKAGING TYPE AND QUANTITY	Pieces/Bill unit: 4 Bill units/MP: 4
BILL UNIT DIMENSIONS	Length: 163 mm Width: 163 mm Height: 105 mm Weight: 483 gr
MASTERPACK DIMENSIONS	Length: 339 mm Width: 175 mm Height: 222 mm Weight: 2099 gr
EURO PALLET	Bill units/pallet: 448 Bill units/layer: 56 Layers/pallet: 8
CONTAINER PALLET HIGH CUBE	Bill units/pallet: 840 Bill units/layer: 84 Layers/pallet: 10
EAN BILL UNIT	 9 006206 529728





Cabernet
Value Gift Pack - Pay 3 Get 4



Riesling
Value Gift Pack - Pay 3 Get 4

ITEM	Item no.:	7414/0	Item no.:	7414/15
	fine crystal machine-made		fine crystal machine-made	
	Height/glass:	121 mm	Height/glass:	108 mm
PACKAGING TYPE AND QUANTITY	Capacity/glass:	600 ccm	Capacity/glass:	375 ccm
	Design:	2022	Design:	2022
	Pieces/Bill unit:	4	Pieces/Bill unit:	4
BILL UNIT DIMENSIONS	Bill units/MP:	4	Bill units/MP:	4
	Length:	201 mm	Length:	170 mm
	Width:	201 mm	Width:	170 mm
	Height:	131 mm	Height:	118 mm
MASTERPACK DIMENSIONS	Weight:	596 gr	Weight:	516 gr
	Length:	412 mm	Length:	346 mm
	Width:	213 mm	Width:	177 mm
	Height:	281 mm	Height:	245 mm
EURO PALLET	Weight:	2585 gr	Weight:	2210 gr
	Bill units/pallet:	168	Bill units/pallet:	336
	Bill units/layer:	28	Bill units/layer:	48
CONTAINER PALLET HIGH CUBE	Layers/pallet:	6	Layers/pallet:	7
	Bill units/pallet:	384	Bill units/pallet:	648
	Bill units/layer:	48	Bill units/layer:	72
EAN BILL UNIT	Layers/pallet:	8	Layers/pallet:	9
	9 006206 52248		9 006206 324026	





Viognier/Chardonnay
Value Gift Pack - Pay 3 Get 4

ITEM	Item no.: 7414/05 fine crystal machine-made Height/glass: 96 mm Capacity/glass: 320 ccm Design: 2022
PACKAGING TYPE AND QUANTITY	Pieces/Bill unit: 4 Bill units/MP: 4
BILL UNIT DIMENSIONS	Length: 170 mm Width: 170 mm Height: 118 mm Weight: 500 gr
MASTERPACK DIMENSIONS	Length: 339 mm Width: 175 mm Height: 222 mm Weight: 2167 gr
EURO PALLET	Bill units/pallet: 448 Bill units/layer: 56 Layers/pallet: 8
CONTAINER PALLET HIGH CUBE	Bill units/pallet: 840 Bill units/layer: 84 Layers/pallet: 10
EAN BILL UNIT	





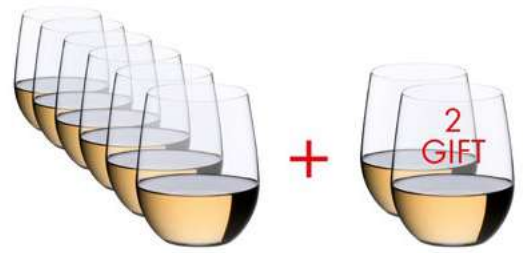

O Wine Tumbler Cabernet/Merlot
Value Gift Pack - Pay 6 Get 8



O Wine Tumbler Viognier/Chardonnay
Value Gift Pack - Pay 6 Get 8

ITEM	Item no.:	5414/80	Item no.:	5414/85
	fine crystal machine-made		fine crystal machine-made	
	Height/glass:	121 mm	Height/glass:	96 mm
PACKAGING TYPE AND QUANTITY	Capacity/glass:	600 ccm	Capacity/glass:	320 ccm
	Design:	2007	Design:	2007
	Pieces/Bill unit:	8	Pieces/Bill unit:	8
BILL UNIT DIMENSIONS	Bill units/MP:	4	Bill units/MP:	4
	Length:	395 mm	Length:	332 mm
	Width:	199 mm	Width:	166 mm
	Height:	129 mm	Height:	104 mm
MASTERPACK DIMENSIONS	Weight:	1157 gr	Weight:	955 gr
	Length:	411 mm	Length:	349 mm
	Width:	416 mm	Width:	344 mm
	Height:	280 mm	Height:	230 mm
EURO PALLET	Weight:	5145 gr	Weight:	4180 gr
	Bill units/pallet:	96	Bill units/pallet:	192
	Bill units/layer:	24	Bill units/layer:	24
CONTAINER PALLET HIGH CUBE	Layers/pallet:	4	Layers/pallet:	8
	Bill units/pallet:	200	Bill units/pallet:	360
	Bill units/layer:	40	Bill units/layer:	36
EAN BILL UNIT	Layers/pallet:	5	Layers/pallet:	10
				







8 Wine Tumbler Cabernet/Merlot + Viognier/Chardonnay
Value Gift Pack - Pay 6 Get 8



4x Cabernet/Merlot + 1x Syrah Decanter
O + Gift

ITEM	Item no.: 5414/50	Item no.: 5414/30
	fine crystal machine-made	fine crystal machine-made
	Height/glass: -	Height/glass: -
	Capacity/glass: -	Capacity/glass: -
	Design: 2009	Design: 2011
PACKAGING TYPE AND QUANTITY	Pieces/Bill unit: 8 Bill units/MP: 4	Pieces/Bill unit: 5 Bill units/MP: 2
BILL UNIT DIMENSIONS	Length: 395 mm Width: 199 mm Height: 129 mm Weight: 1155 gr	Length: 268 mm Width: 207 mm Height: 268 mm Weight: 1228 gr
MASTERPACK DIMENSIONS	Length: 411 mm Width: 416 mm Height: 280 mm Weight: 5110 gr	Length: 421 mm Width: 278 mm Height: 282 mm Weight: 2782 gr
EURO PALLET	Bill units/pallet: 96 Bill units/layer: 24 Layers/pallet: 4	Bill units/pallet: 72 Bill units/layer: 12 Layers/pallet: 6
CONTAINER PALLET HIGH CUBE	Bill units/pallet: 200 Bill units/layer: 40 Layers/pallet: 5	Bill units/pallet: 144 Bill units/layer: 18 Layers/pallet: 8
EAN BILL UNIT	 9 006206 515240	 9 006206 516216

VALUE GIFT PACKS



SWIRL



SWIRL (2010)

Swirl was named after the ease with which they enable the wine to be swirled.



The series has a wavy shape with subtle curves, meaning the glass sits in the hand better and allows the wine to be swirled in the glass particularly well. With a tiny hand movement the wine is effortlessly opened out and aerated with each gentle swirl. These stemless glasses are also endlessly versatile.



Red Wine



White Wine

ITEM	Item no.: 0450/30 fine crystal machine-made	Item no.: 0450/33 fine crystal machine-made
	Height/glass: 120 mm	Height/glass: 103 mm
	Capacity/glass: 580 ccm	Capacity/glass: 380 ccm
	Design: 2010	Design: 2010
PACKAGING	Pieces/Bill unit: 2	Pieces/Bill unit: 2
TYPE AND QUANTITY	Bill units/MP: 4	Bill units/MP: 4
BILL UNIT	Length: 190 mm	Length: 170 mm
DIMENSIONS	Width: 96 mm	Width: 84 mm
	Height: 123 mm	Height: 109 mm
	Weight: 317 gr	Weight: 257 gr
MASTERPACK	Length: 262 mm	Length: 228 mm
DIMENSIONS	Width: 201 mm	Width: 181 mm
	Height: 203 mm	Height: 185 mm
	Weight: 1400 gr	Weight: 1122 gr
EURO PALLET	Bill units/pallet: 540	Bill units/pallet: 840
	Bill units/layer: 60	Bill units/layer: 84
	Layers/pallet: 9	Layers/pallet: 10
CONTAINER PALLET	Bill units/pallet: 1056	Bill units/pallet: 1392
HIGH CUBE	Bill units/layer: 96	Bill units/layer: 116
	Layers/pallet: 11	Layers/pallet: 12
EAN	 9 006206 516049	 9 006206 516056
BILL UNIT		



—Cocktails—
RIEDEL
THE SPIRIT GLASS COMPANY



RIEDEL MIXING SETS (2019)

The renaissance of cocktails and bar drinks has long since ceased to be an insider tip.

After the great international success of the RIEDEL Gin & Tonic sets in 2019, RIEDEL presented the Mixing Tonic, Mixing Rum and Champagne Cocktail sets in 2020 as the perfect addition for all those who like to create and mix their own cocktails.

In 2022, for the enjoyment of pure spirits, a Rum set and a Tequila set have been added to the collection.



MACHINE-MADE



Mixing Champagne Set



RIEDEL Spritz Drinks Set

ITEM	<p>Item no.: 5515/58</p> <p>fine crystal machine-made</p> <p>Height/glass: 221 mm</p> <p>Capacity/glass: 440 ccm</p> <p>Design: 2020</p>	<p>Item no.: 5515/0</p> <p>fine crystal machine-made</p> <p>Height/glass: 224 mm</p> <p>Capacity/glass: 560 ccm</p> <p>Design: 2021</p>
PACKAGING TYPE AND QUANTITY	<p>Pieces/Bill unit: 4</p> <p>Bill units/MP: 4</p>	<p>Pieces/Bill unit: 4</p> <p>Bill units/MP: 2</p>
BILL UNIT DIMENSIONS	<p>Length: 173 mm</p> <p>Width: 171 mm</p> <p>Height: 230 mm</p> <p>Weight: 790 gr</p>	<p>Length: 185 mm</p> <p>Width: 185 mm</p> <p>Height: 232 mm</p> <p>Weight: 855 gr</p>
MASTERPACK DIMENSIONS	<p>Length: 366 mm</p> <p>Width: 366 mm</p> <p>Height: 244 mm</p> <p>Weight: 3458 gr</p>	<p>Length: 388 mm</p> <p>Width: 202 mm</p> <p>Height: 251 mm</p> <p>Weight: 1906 gr</p>
EURO PALLET	<p>Bill units/pallet: 168</p> <p>Bill units/layer: 24</p> <p>Layers/pallet: 7</p>	<p>Bill units/pallet: 168</p> <p>Bill units/layer: 24</p> <p>Layers/pallet: 7</p>
CONTAINER PALLET HIGH CUBE	<p>Bill units/pallet: 216</p> <p>Bill units/layer: 24</p> <p>Layers/pallet: 9</p>	<p>Bill units/pallet: 270</p> <p>Bill units/layer: 30</p> <p>Layers/pallet: 9</p>
EAN BILL UNIT	 <p>9 006206 531448</p>	 <p>9 006206 321841</p>







Mixing Rum Set



Mixing Tonic Set

MACHINE-MADE

ITEM	Item no.: 5515/5255 fine crystal machine-made Height/glass: 102 mm Capacity/glass: 323 ccm Design: 2020	Item no.: 5515/90 fine crystal machine-made Height/glass: 113 mm Capacity/glass: 580 ccm Design: 2020
PACKAGING TYPE AND QUANTITY	Pieces/Bill unit: 4 Bill units/MP: 4	Pieces/Bill unit: 4 Bill units/MP: 4
BILL UNIT DIMENSIONS	Length: 170 mm Width: 170 mm Height: 110 mm Weight: 1630 gr	Length: 201 mm Width: 201 mm Height: 128 mm Weight: 680 gr
MASTERPACK DIMENSIONS	Length: 354 mm Width: 181 mm Height: 237 mm Weight: 6786 gr	Length: 408 mm Width: 210 mm Height: 270 mm Weight: 2921 gr
EURO PALLET	Bill units/pallet: 240 Bill units/layer: 48 Layers/pallet: 5	Bill units/pallet: 196 Bill units/layer: 28 Layers/pallet: 7
CONTAINER PALLET HIGH CUBE	Bill units/pallet: 300 Bill units/layer: 60 Layers/pallet: 5	Bill units/pallet: 384 Bill units/layer: 48 Layers/pallet: 8
EAN BILL UNIT	 9 006206 531462	 9 006206 531455





Gin Set
Classic

Gin Set
Optic „O“

ITEM	Item no.: 5414/67 fine crystal machine-made	Item no.: 5515/67 fine crystal machine-made
	Height/glass: 124 mm Capacity/glass: 762 ccm Design: 2018	Height/glass: 124 mm Capacity/glass: 762 ccm Design: 2019
PACKAGING TYPE AND QUANTITY	Pieces/Bill unit: 4 Bill units/MP: 4	Pieces/Bill unit: 4 Bill units/MP: 4
BILL UNIT DIMENSIONS	Length: 219 mm Width: 219 mm Height: 130 mm Weight: 681 gr	Length: 219 mm Width: 219 mm Height: 130 mm Weight: 681 gr
MASTERPACK DIMENSIONS	Length: 451 mm Width: 231 mm Height: 278 mm Weight: 2992 gr	Length: 451 mm Width: 231 mm Height: 278 mm Weight: 2992 gr
EURO PALLET	Bill units/pallet: 168 Bill units/layer: 28 Layers/pallet: 6	Bill units/pallet: 168 Bill units/layer: 28 Layers/pallet: 6
CONTAINER PALLET HIGH CUBE	Bill units/pallet: 320 Bill units/layer: 40 Layers/pallet: 8	Bill units/pallet: 320 Bill units/layer: 40 Layers/pallet: 8
EAN BILL UNIT	 9 006206 528134	 9 006206 530250





Aperitivo Set

ITEM	Item no.:	5260/51
	fine crystal	
	machine-made	
	Height/glass:	261 mm
	Capacity/glass:	995 ccm
	Design:	2019
PACKAGING	Pieces/Bill unit:	4
TYPE AND QUANTITY	Bill units/MP:	2
BILL UNIT	Length:	226 mm
DIMENSIONS	Width:	226 mm
	Height:	271 mm
	Weight:	1190 gr
MASTERPACK	Length:	463 mm
DIMENSIONS	Width:	237 mm
	Height:	282 mm
	Weight:	2661 gr
EURO PALLET	Bill units/pallet:	84
	Bill units/layer:	14
	Layers/pallet:	6
CONTAINER PALLET	Bill units/pallet:	160
HIGH CUBE	Bill units/layer:	20
	Layers/pallet:	8
EAN		
BILL UNIT		



NEW



Mixing Set Rosé

NEW



Mixing Set Cognac

ITEM	<p>Item no.: 5515/55</p> <p>fine crystal machine-made</p> <p>Height/glass: 230 mm</p> <p>Capacity/glass: 322 ccm</p> <p>Design: 2023</p>	<p>Item no.: 5515/71</p> <p>fine crystal machine-made</p> <p>Height/glass: 190 mm</p> <p>Capacity/glass: 175 ccm</p> <p>Design: 2023</p>
PACKAGING TYPE AND QUANTITY	<p>Pieces/Bill unit: 4</p> <p>Bill units/MP: 4</p>	<p>Pieces/Bill unit: 4</p> <p>Bill units/MP: 2</p>
BILL UNIT DIMENSIONS	<p>Length: 177 mm</p> <p>Width: 177 mm</p> <p>Height: 241 mm</p> <p>Weight: 768 gr</p>	<p>Length: 150 mm</p> <p>Width: 150 mm</p> <p>Height: 200 mm</p> <p>Weight: 572 gr</p>
MASTERPACK DIMENSIONS	<p>Length: 364 mm</p> <p>Width: 364 mm</p> <p>Height: 254 mm</p> <p>Weight: 3368 gr</p>	<p>Length: 308 mm</p> <p>Width: 157 mm</p> <p>Height: 214 mm</p> <p>Weight: 1256 gr</p>
EURO PALLET	<p>Bill units/pallet: 168</p> <p>Bill units/layer: 24</p> <p>Layers/pallet: 7</p>	<p>Bill units/pallet: 272</p> <p>Bill units/layer: 34</p> <p>Layers/pallet: 8</p>
CONTAINER PALLET HIGH CUBE	<p>Bill units/pallet: 216</p> <p>Bill units/layer: 24</p> <p>Layers/pallet: 9</p>	<p>Bill units/pallet: 420</p> <p>Bill units/layer: 42</p> <p>Layers/pallet: 10</p>
EAN BILL UNIT	 <p>9 006206 325771</p>	 <p>9 006206 325764</p>





RIEDEL Tequila Set



RIEDEL Rum Set

MACHINE-MADE

ITEM	Item no.: 5515/18 fine crystal machine-made Height/glass: 210 mm Capacity/glass: 190 ccm Design: 2022	Item no.: 5515/11 fine crystal machine-made Height/glass: 205 mm Capacity/glass: 200 ccm Design: 2022
PACKAGING	Pieces/Bill unit: 4	Pieces/Bill unit: 4
TYPE AND QUANTITY	Bill units/MP: 4	Bill units/MP: 4
BILL UNIT	Length: 145 mm	Length: 165 mm
DIMENSIONS	Width: 145 mm	Width: 165 mm
	Height: 219 mm	Height: 217 mm
	Weight: 618 gr	Weight: 634 gr
MASTERPACK	Length: 300 mm	Length: 340 mm
DIMENSIONS	Width: 300 mm	Width: 340 mm
	Height: 231 mm	Height: 230 mm
	Weight: 2674 gr	Weight: 2798 gr
EURO PALLET	Bill units/pallet: 192	Bill units/pallet: 192
	Bill units/layer: 32	Bill units/layer: 24
	Layers/pallet: 6	Layers/pallet: 8
CONTAINER PALLET	Bill units/pallet: 432	Bill units/pallet: 324
HIGH CUBE	Bill units/layer: 48	Bill units/layer: 36
	Layers/pallet: 9	Layers/pallet: 9
EAN		
BILL UNIT	9 006206 322725	9 006206 323333





Tequila



Cognac



Port



Brandy

ITEM	Item no.: fine crystal machine-made	6408/18	Item no.: fine crystal premium machine-made	6416/71	Item no.: fine crystal premium machine-made	6416/60	Item no.: fine crystal premium machine-made	6416/18
	Height/glass:	210 mm	Height/glass:	184 mm	Height/glass:	168 mm	Height/glass:	151 mm
	Capacity/glass:	190 ccm	Capacity/glass:	170 ccm	Capacity/glass:	240 ccm	Capacity/glass:	885 ccm
	Design:	1998	Design:	1998	Design:	1991	Design:	1998
PACKAGING	Pieces/Bill unit:	2	Pieces/Bill unit:	2	Pieces/Bill unit:	2	Pieces/Bill unit:	2
TYPE AND QUANTITY	Bill units/MP:	4	Bill units/MP:	4	Bill units/MP:	4	Bill units/MP:	4
BILL UNIT	Length:	185 mm	Length:	227 mm	Length:	272 mm	Length:	272 mm
DIMENSIONS	Width:	92 mm	Width:	116 mm	Width:	138 mm	Width:	138 mm
	Height:	237 mm	Height:	275 mm	Height:	205 mm	Height:	205 mm
	Weight:	405 gr	Weight:	532 gr	Weight:	530 gr	Weight:	576 gr
MASTERPACK	Length:	378 mm	Length:	469 mm	Length:	573 mm	Length:	573 mm
DIMENSIONS	Width:	192 mm	Width:	235 mm	Width:	283 mm	Width:	283 mm
	Height:	247 mm	Height:	285 mm	Height:	215 mm	Height:	215 mm
	Weight:	1850 gr	Weight:	2432 gr	Weight:	2463 gr	Weight:	2627 gr
EURO PALLET	Bill units/pallet:	336	Bill units/pallet:	168	Bill units/pallet:	144	Bill units/pallet:	144
	Bill units/layer:	48	Bill units/layer:	28	Bill units/layer:	16	Bill units/layer:	16
	Layers/pallet:	7	Layers/pallet:	6	Layers/pallet:	9	Layers/pallet:	9
CONTAINER PALLET	Bill units/pallet:	624	Bill units/pallet:	320	Bill units/pallet:	264	Bill units/pallet:	264
HIGH CUBE	Bill units/layer:	104	Bill units/layer:	40	Bill units/layer:	24	Bill units/layer:	24
	Layers/pallet:	6	Layers/pallet:	8	Layers/pallet:	11	Layers/pallet:	11
EAN								
BILL UNIT	9 006206 514793		9 006206 513710		9 006206 513741		9 006206 514045	





Single Malt Whisky



Beer

ITEM	Item no.: 6416/80 fine crystal premium machine-made	Item no.: 6408/11 fine crystal machine-made
	Height/glass: 113 mm	Height/glass: 170 mm
	Capacity/glass: 200 ccm	Capacity/glass: 500 ccm
	Design: 1991	Design: 2002
PACKAGING TYPE AND QUANTITY	Pieces/Bill unit: 2 Bill units/MP: 4	Pieces/Bill unit: 2 Bill units/MP: 4
BILL UNIT DIMENSIONS	Length: 272 mm Width: 138 mm Height: 205 mm Weight: 510 gr	Length: 183 mm Width: 92 mm Height: 180 mm Weight: 410 gr
MASTERPACK DIMENSIONS	Length: 573 mm Width: 283 mm Height: 215 mm Weight: 2383 gr	Length: 378 mm Width: 190 mm Height: 190 mm Weight: 1800 gr
EURO PALLET	Bill units/pallet: 144 Bill units/layer: 16 Layers/pallet: 9	Bill units/pallet: 480 Bill units/layer: 48 Layers/pallet: 10
CONTAINER PALLET HIGH CUBE	Bill units/pallet: 264 Bill units/layer: 24 Layers/pallet: 11	Bill units/pallet: 720 Bill units/layer: 60 Layers/pallet: 12
EAN BILL UNIT	 9 006206 513727	 9 006206 514908





MAXIMILIAN J. RIEDEL
11TH GENERATION

THE ART OF DECANTING WINE







Amadeo Double Magnum Decanter



Horn Decanter

ITEM	Item no.:	1756/80	Item no.:	2014/02
	fine crystal handmade		fine crystal handmade	
	Height:	680 mm	Height:	370 mm
PACKAGING TYPE AND QUANTITY	Capacity:	3000 ccm	Capacity:	2500 ccm
	Design:	2014	Design:	2014
	Pieces/Bill unit:	1	Pieces/Bill unit:	1
BILL UNIT DIMENSIONS	Bill units/MP:	1	Bill units/MP:	1
	Length:	412 mm	Length:	303 mm
	Width:	207 mm	Width:	183 mm
	Height:	755 mm	Height:	458 mm
MASTERPACK DIMENSIONS	Weight:	3000 gr	Weight:	1207 gr
	Length:	422 mm	Length:	314 mm
	Width:	218 mm	Width:	194 mm
	Height:	766 mm	Height:	464 mm
EURO PALLET	Weight:	3500 gr	Weight:	1383 gr
	Bill units/pallet:	20	Bill units/pallet:	56
	Bill units/layer:	5	Bill units/layer:	14
CONTAINER PALLET HIGH CUBE	Layers/pallet:	4	Layers/pallet:	4
	Bill units/pallet:	36	Bill units/pallet:	100
	Bill units/layer:	12	Bill units/layer:	20
EAN BILL UNIT	Layers/pallet:	3	Layers/pallet:	5
	 9 006206 214051		 9 006206 311743	







Black Tie Decanter



Decanter Tyrol



Horse Decanter

ITEM	Item no.: 4100/23 fine crystal handmade Height: 420 mm Capacity: 1955 ccm Design: 2009	Item no.: 1405/13 fine crystal handmade Height: 192 mm Capacity: 1870 ccm Design: 2007	Item no.: 4101/13 fine crystal handmade Height: 600 mm Capacity: 1766 ccm Design: 2014
PACKAGING TYPE AND QUANTITY	Pieces/Bill unit: 1 Bill units/MP: 1	Pieces/Bill unit: 1 Bill units/MP: 1	Pieces/Bill unit: 1 Bill units/MP: 1
BILL UNIT DIMENSIONS	Length: 279 mm Width: 275 mm Height: 551 mm Weight: 1246 gr	Length: 279 mm Width: 275 mm Height: 551 mm Weight: 1746 gr	Length: 275 mm Width: 225 mm Height: 632 mm Weight: 1532 gr
MASTERPACK DIMENSIONS	Length: 290 mm Width: 281 mm Height: 556 mm Weight: 1484 gr	Length: 290 mm Width: 281 mm Height: 556 mm Weight: 1984 gr	Length: 286 mm Width: 234 mm Height: 634 mm Weight: 1780 gr
EURO PALLET	Bill units/pallet: 24 Bill units/layer: 4 Layers/pallet: 6	Bill units/pallet: 24 Bill units/layer: 4 Layers/pallet: 6	Bill units/pallet: 30 Bill units/layer: 5 Layers/pallet: 6
CONTAINER PALLET HIGH CUBE	Bill units/pallet: 48 Bill units/layer: 6 Layers/pallet: 8	Bill units/pallet: 48 Bill units/layer: 6 Layers/pallet: 8	Bill units/pallet: 54 Bill units/layer: 6 Layers/pallet: 9
EAN BILL UNIT	 9 006206 311439	 9 006206 311354	 9 006206 311798

DECANTERS

CAUTION: the indented design feature of this decanter must not be used as a handle. Do not insert your hand or any item into the indented area. Cleaning beads should not be used. Carefully hand wash only.





Black Tie Face To Face Decanter



Mamba Decanter



Eve Decanter

ITEM	Item no.: 4100/13 fine crystal handmade	Item no.: 1950/19 fine crystal handmade	Item no.: 1950/09 fine crystal handmade
	Height: 600 mm Capacity: 1766 ccm Design: 2009	Height: 325 mm Capacity: 1500 ccm Design: 2011	Height: 505 mm Capacity: 1370 ccm Design: 2009
PACKAGING TYPE AND QUANTITY	Pieces/Bill unit: 1 Bill units/MP: 1	Pieces/Bill unit: 1 Bill units/MP: 1	Pieces/Bill unit: 1 Bill units/MP: 1
BILL UNIT DIMENSIONS	Length: 275 mm Width: 225 mm Height: 632 mm Weight: 1532 gr	Length: 420 mm Width: 267 mm Height: 435 mm Weight: 1660 gr	Length: 279 mm Width: 275 mm Height: 551 mm Weight: 1346 gr
MASTERPACK DIMENSIONS	Length: 286 mm Width: 234 mm Height: 634 mm Weight: 1780 gr	Length: 425 mm Width: 273 mm Height: 445 mm Weight: 2020 gr	Length: 290 mm Width: 281 mm Height: 556 mm Weight: 1584 gr
EURO PALLET	Bill units/pallet: 30 Bill units/layer: 5 Layers/pallet: 6	Bill units/pallet: 24 Bill units/layer: 6 Layers/pallet: 4	Bill units/pallet: 24 Bill units/layer: 4 Layers/pallet: 6
CONTAINER PALLET HIGH CUBE	Bill units/pallet: 54 Bill units/layer: 6 Layers/pallet: 9	Bill units/pallet: 45 Bill units/layer: 9 Layers/pallet: 5	Bill units/pallet: 48 Bill units/layer: 6 Layers/pallet: 8
EAN BILL UNIT	 9 006206 311446	 9 006206 311484	 9 006206 311422

CAUTION: the indented design feature of this decanter must not be used as a handle. Do not insert your hand or any item into the indented area. Cleaning beads should not be used. Carefully hand wash only.



Boa Decanter







Amadeo Decanter
Blue



Amadeo Decanter
Menta



Amadeo Decanter
Rosa

ITEM	Item no.: fine crystal handmade	2013/01	Item no.: fine crystal handmade	1756/13B	Item no.: fine crystal handmade	1756/13-M	Item no.: fine crystal handmade	1756/13-R
	Height:	350 mm	Height:	350 mm	Height:	350 mm	Height:	350 mm
	Capacity:	1957 ccm	Capacity:	1500 ccm	Capacity:	1500 ccm	Capacity:	1500 ccm
	Design:	2013	Design:	2022	Design:	2019	Design:	2019
PACKAGING	Pieces/Bill unit:	1	Pieces/Bill unit:	1	Pieces/Bill unit:	1	Pieces/Bill unit:	1
TYPE AND QUANTITY	Bill units/MP:	1	Bill units/MP:	1	Bill units/MP:	1	Bill units/MP:	1
BILL UNIT	Length:	279 mm	Length:	303 mm	Length:	303 mm	Length:	303 mm
DIMENSIONS	Width:	275 mm	Width:	183 mm	Width:	183 mm	Width:	183 mm
	Height:	551 mm	Height:	458 mm	Height:	458 mm	Height:	458 mm
	Weight:	1316 gr	Weight:	1097 gr	Weight:	1097 gr	Weight:	1097 gr
MASTERPACK	Length:	290 mm	Length:	314 mm	Length:	314 mm	Length:	314 mm
DIMENSIONS	Width:	281 mm	Width:	194 mm	Width:	194 mm	Width:	194 mm
	Height:	556 mm	Height:	464 mm	Height:	464 mm	Height:	464 mm
	Weight:	1554 gr	Weight:	1273 gr	Weight:	1273 gr	Weight:	1273 gr
EURO PALLET	Bill units/pallet:	24	Bill units/pallet:	56	Bill units/pallet:	56	Bill units/pallet:	56
	Bill units/layer:	4	Bill units/layer:	14	Bill units/layer:	14	Bill units/layer:	14
	Layers/pallet:	6	Layers/pallet:	4	Layers/pallet:	4	Layers/pallet:	4
CONTAINER PALLET	Bill units/pallet:	48	Bill units/pallet:	100	Bill units/pallet:	100	Bill units/pallet:	100
HIGH CUBE	Bill units/layer:	6	Bill units/layer:	20	Bill units/layer:	20	Bill units/layer:	20
	Layers/pallet:	8	Layers/pallet:	5	Layers/pallet:	5	Layers/pallet:	5
EAN	 9 006206 213672		 9 006206 324040		 9 006206 313303		 9 006206 313327	
BILL UNIT								







Amadeo Decanter

Black Tie Amadeo Decanter

RIEDEL Winewings Decanter

Swan Decanter

ITEM	Item no.: fine crystal handmade	1756/13	Item no.: fine crystal handmade	4100/83	Item no.: fine crystal handmade	2007/0251	Item no.: fine crystal handmade	2007/02
	Height:	350 mm	Height:	350 mm	Height:	600 mm	Height:	600 mm
	Capacity:	1500 ccm	Capacity:	1500 ccm	Capacity:	850 ccm	Capacity:	1570 ccm
	Design:	2006	Design:	2009	Design:	2020	Design:	2008
PACKAGING	Pieces/Bill unit:	1	Pieces/Bill unit:	1	Pieces/Bill unit:	1	Pieces/Bill unit:	1
TYPE AND QUANTITY	Bill units/MP:	1	Bill units/MP:	1	Bill units/MP:	1	Bill units/MP:	1
BILL UNIT	Length:	303 mm	Length:	303 mm	Length:	275 mm	Length:	275 mm
DIMENSIONS	Width:	183 mm	Width:	183 mm	Width:	225 mm	Width:	225 mm
	Height:	458 mm	Height:	458 mm	Height:	632 mm	Height:	632 mm
	Weight:	1097 gr	Weight:	1067 gr	Weight:	1190 gr	Weight:	1162 gr
MASTERPACK	Length:	314 mm	Length:	314 mm	Length:	286 mm	Length:	286 mm
DIMENSIONS	Width:	194 mm	Width:	194 mm	Width:	234 mm	Width:	234 mm
	Height:	464 mm	Height:	464 mm	Height:	634 mm	Height:	634 mm
	Weight:	1273 gr	Weight:	1243 gr	Weight:	1438 gr	Weight:	1410 gr
EURO PALLET	Bill units/pallet:	56	Bill units/pallet:	56	Bill units/pallet:	30	Bill units/pallet:	30
	Bill units/layer:	14	Bill units/layer:	14	Bill units/layer:	5	Bill units/layer:	5
	Layers/pallet:	4	Layers/pallet:	4	Layers/pallet:	6	Layers/pallet:	6
CONTAINER PALLET	Bill units/pallet:	100	Bill units/pallet:	100	Bill units/pallet:	54	Bill units/pallet:	54
HIGH CUBE	Bill units/layer:	20	Bill units/layer:	20	Bill units/layer:	6	Bill units/layer:	6
	Layers/pallet:	5	Layers/pallet:	5	Layers/pallet:	9	Layers/pallet:	9
EAN								
BILL UNIT	9 006206 212736		9 006206 311408		9 006206 313754		9 006206 311385	



reddot design award



DECANTERS





Amadeo Mini Decanter



Mamba Fatto A Mano Decanter



Amadeo Fatto A Mano Decanter

ITEM	Item no.: 1756/14 fine crystal handmade	Item no.: 1950/00 fine crystal handmade	Item no.: 1756/00 fine crystal handmade
	Height: 250 mm Capacity: 750 ccm Design: 2019	Height: 325 mm Capacity: 1500 ccm Design: 2017	Height: 350 mm Capacity: 1500 ccm Design: 2017
PACKAGING TYPE AND QUANTITY	Pieces/Bill unit: 1 Bill units/MP: 1	Pieces/Bill unit: 1 Bill units/MP: 1	Pieces/Bill unit: 1 Bill units/MP: 1
BILL UNIT DIMENSIONS	Length: 291 mm Width: 198 mm Height: 224 mm Weight: 552 gr	Length: 420 mm Width: 267 mm Height: 435 mm Weight: 1660 gr	Length: 303 mm Width: 183 mm Height: 458 mm Weight: 1097 gr
MASTERPACK DIMENSIONS	Length: - Width: - Height: - Weight: -	Length: 425 mm Width: 273 mm Height: 445 mm Weight: 2020 gr	Length: 314 mm Width: 194 mm Height: 464 mm Weight: 1273 gr
EURO PALLET	Bill units/pallet: 128 Bill units/layer: 16 Layers/pallet: 8	Bill units/pallet: 24 Bill units/layer: 6 Layers/pallet: 4	Bill units/pallet: 56 Bill units/layer: 14 Layers/pallet: 4
CONTAINER PALLET HIGH CUBE	Bill units/pallet: 224 Bill units/layer: 28 Layers/pallet: 8	Bill units/pallet: 45 Bill units/layer: 9 Layers/pallet: 5	Bill units/pallet: 100 Bill units/layer: 20 Layers/pallet: 5
EAN BILL UNIT	 9 006206 312979	 9 006206 312788	 9 006206 312795



Limited Editions: TG reserves the right to offer glassware marked as "Limited Edition" in a certain amount and for a certain time period and under certain allocation criteria to Customer.



NEW



Amadeo Performance Decanter



NEW



RIEDEL Amadeo Moonlight Decanter



RIEDEL Amadeo Sunshine Decanter

ITEM	Item no.:	1756/19	Item no.:	1756/23-M	Item no.:	1756/23-S
	fine crystal handmade		fine crystal handmade		fine crystal handmade	
	Height:	350 mm	Height:	350 mm	Height:	350 mm
	Capacity:	1500 ccm	Capacity:	1500 ccm	Capacity:	1500 ccm
	Design:	2019	Design:	2023	Design:	2023
PACKAGING TYPE AND QUANTITY	Pieces/Bill unit:	1	Pieces/Bill unit:	1	Pieces/Bill unit:	1
	Bill units/MP:	1	Bill units/MP:	1	Bill units/MP:	1
BILL UNIT DIMENSIONS	Length:	303 mm	Length:	397 mm	Length:	397 mm
	Width:	183 mm	Width:	229 mm	Width:	229 mm
	Height:	458 mm	Height:	129 mm	Height:	129 mm
	Weight:	1097 gr	Weight:	1012 gr	Weight:	1012 gr
MASTERPACK DIMENSIONS	Length:	314 mm	Length:	397 mm	Length:	397 mm
	Width:	194 mm	Width:	234 mm	Width:	234 mm
	Height:	464 mm	Height:	135 mm	Height:	135 mm
	Weight:	1273 gr	Weight:	1144 gr	Weight:	1144 gr
EURO PALLET	Bill units/pallet:	56	Bill units/pallet:	91	Bill units/pallet:	91
	Bill units/layer:	14	Bill units/layer:	7	Bill units/layer:	7
	Layers/pallet:	4	Layers/pallet:	13	Layers/pallet:	13
CONTAINER PALLET HIGH CUBE	Bill units/pallet:	100	Bill units/pallet:	208	Bill units/pallet:	208
	Bill units/layer:	20	Bill units/layer:	13	Bill units/layer:	13
	Layers/pallet:	5	Layers/pallet:	16	Layers/pallet:	16
EAN BILL UNIT						
	9 006206 313198		9 006206 325795		9 006206 325788	



Limited Editions: TG reserves the right to offer glassware marked as "Limited Edition" in a certain amount and for a certain time period and under certain allocation criteria to Customer.

LIMITED EDITION OF 500 PIECES.



Limited Editions: TG reserves the right to offer glassware marked as "Limited Edition" in a certain amount and for a certain time period and under certain allocation criteria to Customer.

LIMITED EDITION OF 500 PIECES.

DECANTERS



Ayam Decanter



Ayam Decanter
Black



Duck Decanter

ITEM	Item no.: 2016/01 fine crystal handmade	Item no.: 2016/02 fine crystal handmade	Item no.: 1700/14 fine crystal machine-made
	Height: 287 mm Capacity: 1700 ccm Design: 2016	Height: 287 mm Capacity: 1700 ccm Design: 2016	Height: 130 mm Capacity: 900 ccm Design: 1998
PACKAGING TYPE AND QUANTITY	Pieces/Bill unit: 1 Bill units/MP: 1	Pieces/Bill unit: 1 Bill units/MP: 1	Pieces/Bill unit: 1 Bill units/MP: 1
BILL UNIT DIMENSIONS	Length: 303 mm Width: 183 mm Height: 458 mm Weight: 1147 gr	Length: 303 mm Width: 183 mm Height: 458 mm Weight: 1147 gr	Length: 303 mm Width: 183 mm Height: 458 mm Weight: 1357 gr
MASTERPACK DIMENSIONS	Length: 314 mm Width: 194 mm Height: 464 mm Weight: 1323 gr	Length: 314 mm Width: 194 mm Height: 464 mm Weight: 1323 gr	Length: 314 mm Width: 194 mm Height: 464 mm Weight: 1533 gr
EURO PALLET	Bill units/pallet: 56 Bill units/layer: 14 Layers/pallet: 4	Bill units/pallet: 56 Bill units/layer: 14 Layers/pallet: 4	Bill units/pallet: 56 Bill units/layer: 14 Layers/pallet: 4
CONTAINER PALLET HIGH CUBE	Bill units/pallet: 100 Bill units/layer: 20 Layers/pallet: 5	Bill units/pallet: 100 Bill units/layer: 20 Layers/pallet: 5	Bill units/pallet: 100 Bill units/layer: 20 Layers/pallet: 5
EAN BILL UNIT	 9 006206 312412	 9 006206 312429	 9 006206 727216





RIEDEL Superleggero Decanter



Escargot Decanter



Cornetto Magnum Decanter

ITEM	Item no.: fine crystal handmade	1925/01	Item no.: fine crystal machine-made	2011/02	Item no.: fine crystal handmade	1977/26
	Height:	410 mm	Height:	150 mm	Height:	425 mm
	Capacity:	1585 ccm	Capacity:	1400 ccm	Capacity:	1850 ccm
	Design:	2015	Design:	2011	Design:	2003
PACKAGING	Pieces/Bill unit:	1	Pieces/Bill unit:	1	Pieces/Bill unit:	1
TYPE AND QUANTITY	Bill units/MP:	1	Bill units/MP:	1	Bill units/MP:	1
BILL UNIT	Length:	172 mm	Length:	303 mm	Length:	172 mm
DIMENSIONS	Width:	172 mm	Width:	183 mm	Width:	172 mm
	Height:	476 mm	Height:	458 mm	Height:	476 mm
	Weight:	960 gr	Weight:	1217 gr	Weight:	960 gr
MASTERPACK	Length:	177 mm	Length:	314 mm	Length:	177 mm
DIMENSIONS	Width:	177 mm	Width:	194 mm	Width:	177 mm
	Height:	477 mm	Height:	464 mm	Height:	477 mm
	Weight:	1091 gr	Weight:	1393 gr	Weight:	1091 gr
EURO PALLET	Bill units/pallet:	90	Bill units/pallet:	56	Bill units/pallet:	90
	Bill units/layer:	9	Bill units/layer:	14	Bill units/layer:	9
	Layers/pallet:	10	Layers/pallet:	4	Layers/pallet:	10
CONTAINER PALLET	Bill units/pallet:	182	Bill units/pallet:	100	Bill units/pallet:	182
HIGH CUBE	Bill units/layer:	14	Bill units/layer:	20	Bill units/layer:	14
	Layers/pallet:	13	Layers/pallet:	5	Layers/pallet:	13
EAN	 9 006206 312139		 9 006206 311491		 9 006206 311286	
BILL UNIT						







RIEDEL Cornetto Confetti Decanter
Red

RIEDEL Cornetto Confetti Decanter
Blue

RIEDEL Cornetto Confetti Decanter
Green

Cornetto Fatto A Mano Decanter

ITEM	Item no.: 1977/13R fine crystal handmade	Item no.: 1977/13B fine crystal handmade	Item no.: 1977/13G fine crystal handmade	Item no.: 1977/00 fine crystal handmade
	Height: 325 mm	Height: 325 mm	Height: 325 mm	Height: 325 mm
	Capacity: 1200 ccm	Capacity: 1200 ccm	Capacity: 1200 ccm	Capacity: 1200 ccm
	Design: 2020	Design: 2020	Design: 2020	Design: 2017
PACKAGING	Pieces/Bill unit: 1	Pieces/Bill unit: 1	Pieces/Bill unit: 1	Pieces/Bill unit: 1
TYPE AND QUANTITY	Bill units/MP: 1	Bill units/MP: 1	Bill units/MP: 1	Bill units/MP: 1
BILL UNIT	Length: 172 mm	Length: 172 mm	Length: 172 mm	Length: 172 mm
DIMENSIONS	Width: 172 mm	Width: 172 mm	Width: 172 mm	Width: 172 mm
	Height: 476 mm	Height: 476 mm	Height: 476 mm	Height: 476 mm
	Weight: 660 gr	Weight: 660 gr	Weight: 660 gr	Weight: 660 gr
MASTERPACK	Length: 177 mm	Length: 177 mm	Length: 177 mm	Length: 177 mm
DIMENSIONS	Width: 177 mm	Width: 177 mm	Width: 177 mm	Width: 177 mm
	Height: 477 mm	Height: 477 mm	Height: 477 mm	Height: 477 mm
	Weight: 791 gr	Weight: 791 gr	Weight: 791 gr	Weight: 791 gr
EURO PALLET	Bill units/pallet: 90	Bill units/pallet: 90	Bill units/pallet: 90	Bill units/pallet: 90
	Bill units/layer: 9	Bill units/layer: 9	Bill units/layer: 9	Bill units/layer: 9
	Layers/pallet: 10	Layers/pallet: 10	Layers/pallet: 10	Layers/pallet: 10
CONTAINER PALLET	Bill units/pallet: 182	Bill units/pallet: 182	Bill units/pallet: 182	Bill units/pallet: 182
HIGH CUBE	Bill units/layer: 14	Bill units/layer: 14	Bill units/layer: 14	Bill units/layer: 14
	Layers/pallet: 13	Layers/pallet: 13	Layers/pallet: 13	Layers/pallet: 13
EAN BILL UNIT	 9 006206 313693	 9 006206 313709	 9 006206 313723	 9 006206 312801



DECANTERS



RIEDEL Cornetto Confetti Decanter
Pink



RIEDEL Cornetto Confetti Decanter
Yellow



Curly Decanter



Curly Decanter
Pink

ITEM	Item no.: 1977/13DP fine crystal handmade	Item no.: 1977/13Y fine crystal handmade	Item no.: 2011/04S1 fine crystal handmade	Item no.: 2011/04 fine crystal handmade
	Height: 325 mm Capacity: 1200 ccm Design: 2022	Height: 325 mm Capacity: 1200 ccm Design: 2020	Height: 265 mm Capacity: 1400 ccm Design: 2013	Height: 265 mm Capacity: 1400 ccm Design: 2013
PACKAGING TYPE AND QUANTITY	Pieces/Bill unit: 1 Bill units/MP: 1	Pieces/Bill unit: 1 Bill units/MP: 1	Pieces/Bill unit: 1 Bill units/MP: 1	Pieces/Bill unit: 1 Bill units/MP: 1
BILL UNIT DIMENSIONS	Length: 172 mm Width: 172 mm Height: 476 mm Weight: 660 gr	Length: 172 mm Width: 172 mm Height: 476 mm Weight: 660 gr	Length: 303 mm Width: 183 mm Height: 458 mm Weight: 1047 gr	Length: 303 mm Width: 183 mm Height: 458 mm Weight: 1047 gr
MASTERPACK DIMENSIONS	Length: 177 mm Width: 177 mm Height: 477 mm Weight: 791 gr	Length: 177 mm Width: 177 mm Height: 477 mm Weight: 791 gr	Length: 314 mm Width: 194 mm Height: 464 mm Weight: 1223 gr	Length: 314 mm Width: 194 mm Height: 464 mm Weight: 1223 gr
EURO PALLET	Bill units/pallet: 90 Bill units/layer: 9 Layers/pallet: 10	Bill units/pallet: 90 Bill units/layer: 9 Layers/pallet: 10	Bill units/pallet: 56 Bill units/layer: 14 Layers/pallet: 4	Bill units/pallet: 56 Bill units/layer: 14 Layers/pallet: 4
CONTAINER PALLET HIGH CUBE	Bill units/pallet: 182 Bill units/layer: 14 Layers/pallet: 13	Bill units/pallet: 182 Bill units/layer: 14 Layers/pallet: 13	Bill units/pallet: 100 Bill units/layer: 20 Layers/pallet: 5	Bill units/pallet: 100 Bill units/layer: 20 Layers/pallet: 5
EAN BILL UNIT				



Curly Fatto A Mano Decanter







Decanter „O“
Magnum



Ultra Magnum Decanter



Cornetto Single Decanter

ITEM	Item no.: fine crystal handmade	2011/00	Item no.: fine crystal handmade	1414/26	Item no.: fine crystal handmade	2400/13	Item no.: fine crystal handmade	1977/13
	Height:	265 mm	Height:	385 mm	Height:	240 mm	Height:	325 mm
	Capacity:	1400 ccm	Capacity:	2300 ccm	Capacity:	2000 ccm	Capacity:	1200 ccm
	Design:	2018	Design:	2005	Design:	1994	Design:	2003
PACKAGING	Pieces/Bill unit:	1	Pieces/Bill unit:	1	Pieces/Bill unit:	1	Pieces/Bill unit:	1
TYPE AND QUANTITY	Bill units/MP:	1	Bill units/MP:	1	Bill units/MP:	1	Bill units/MP:	1
BILL UNIT	Length:	303 mm	Length:	172 mm	Length:	290 mm	Length:	172 mm
DIMENSIONS	Width:	183 mm	Width:	172 mm	Width:	290 mm	Width:	172 mm
	Height:	458 mm	Height:	476 mm	Height:	308 mm	Height:	476 mm
	Weight:	1047 gr	Weight:	1050 gr	Weight:	1301 gr	Weight:	660 gr
MASTERPACK	Length:	314 mm	Length:	177 mm	Length:	299 mm	Length:	177 mm
DIMENSIONS	Width:	194 mm	Width:	177 mm	Width:	299 mm	Width:	177 mm
	Height:	464 mm	Height:	477 mm	Height:	314 mm	Height:	477 mm
	Weight:	1223 gr	Weight:	1181 gr	Weight:	1440 gr	Weight:	791 gr
EURO PALLET	Bill units/pallet:	56	Bill units/pallet:	90	Bill units/pallet:	48	Bill units/pallet:	90
	Bill units/layer:	14	Bill units/layer:	9	Bill units/layer:	8	Bill units/layer:	9
	Layers/pallet:	4	Layers/pallet:	10	Layers/pallet:	6	Layers/pallet:	10
CONTAINER PALLET	Bill units/pallet:	100	Bill units/pallet:	182	Bill units/pallet:	84	Bill units/pallet:	182
HIGH CUBE	Bill units/layer:	20	Bill units/layer:	14	Bill units/layer:	12	Bill units/layer:	14
	Layers/pallet:	5	Layers/pallet:	13	Layers/pallet:	7	Layers/pallet:	13
EAN	 9 006206 312924		 9 006206 311316		 9 006206 310036		 9 006206 311279	
BILL UNIT								





Black Tie Occhio Nero Decanter



RIEDEL Decanter





RIEDEL Sakura Decanter

ITEM	Item no.: 2009/04 fine crystal handmade	Item no.: 2015/02 fine crystal handmade	Item no.: 2021/55 fine crystal handmade
	Height: 365 mm Capacity: 1210 ccm Design: 2010	Height: 365 mm Capacity: 1210 ccm Design: 2015	Height: 365 mm Capacity: 1210 ccm Design: 2021
PACKAGING TYPE AND QUANTITY	Pieces/Bill unit: 1 Bill units/MP: 1	Pieces/Bill unit: 1 Bill units/MP: 1	Pieces/Bill unit: 1 Bill units/MP: 1
BILL UNIT DIMENSIONS	Length: 172 mm Width: 172 mm Height: 476 mm Weight: 990 gr	Length: 172 mm Width: 172 mm Height: 476 mm Weight: 990 gr	Length: 172 mm Width: 172 mm Height: 476 mm Weight: 990 gr
MASTERPACK DIMENSIONS	Length: 177 mm Width: 177 mm Height: 477 mm Weight: 1121 gr	Length: 177 mm Width: 177 mm Height: 477 mm Weight: 1121 gr	Length: 177 mm Width: 177 mm Height: 477 mm Weight: 1121 gr
EURO PALLET	Bill units/pallet: 90 Bill units/layer: 9 Layers/pallet: 10	Bill units/pallet: 90 Bill units/layer: 9 Layers/pallet: 10	Bill units/pallet: 90 Bill units/layer: 9 Layers/pallet: 10
CONTAINER PALLET HIGH CUBE	Bill units/pallet: 182 Bill units/layer: 14 Layers/pallet: 13	Bill units/pallet: 182 Bill units/layer: 14 Layers/pallet: 13	Bill units/pallet: 182 Bill units/layer: 14 Layers/pallet: 13
EAN BILL UNIT	 9 006206 213085	 9 006206 312153	 9 006206 322008



RIEDEL Chinese Zodiac Rabbit Decanter Red/Yellow RIEDEL Chinese Zodiac Dragon Decanter Red/Yellow

ITEM	Item no.: 2009/2351 fine crystal handmade	Item no.: 2009/2451 fine crystal handmade
	Height: 365 mm	Height: 365 mm
	Capacity: 1210 ccm	Capacity: 1210 ccm
	Design: 2023	Design: 2024
PACKAGING TYPE AND QUANTITY	Pieces/Bill unit: 1 Bill units/MP: 1	Pieces/Bill unit: 1 Bill units/MP: 1
BILL UNIT DIMENSIONS	Length: 172 mm Width: 172 mm Height: 476 mm Weight: 990 gr	Length: 172 mm Width: 172 mm Height: 476 mm Weight: 990 gr
MASTERPACK DIMENSIONS	Length: 177 mm Width: 177 mm Height: 477 mm Weight: 1121 gr	Length: 177 mm Width: 177 mm Height: 477 mm Weight: 1121 gr
EURO PALLET	Bill units/pallet: 90 Bill units/layer: 9 Layers/pallet: 10	Bill units/pallet: 90 Bill units/layer: 9 Layers/pallet: 10
CONTAINER PALLET HIGH CUBE	Bill units/pallet: 182 Bill units/layer: 14 Layers/pallet: 13	Bill units/pallet: 182 Bill units/layer: 14 Layers/pallet: 13
EAN BILL UNIT	 9 006206 325009	 9 006206 325719



Limited Editions: TG reserves the right to offer glassware marked as "Limited Edition" in a certain amount and for a certain time period and under certain allocation criteria to Customer.



Limited Editions: TG reserves the right to offer glassware marked as "Limited Edition" in a certain amount and for a certain time period and under certain allocation criteria to Customer.



Black Tie Smile Decanter







Black Tie Touch Decanter



Black Tie Bliss Decanter



Black Tie Smile Decanter
Red

ITEM	Item no.: 2009/01 fine crystal handmade	Item no.: 2009/02 fine crystal handmade	Item no.: 2009/03 fine crystal handmade	Item no.: 2009/01S3 fine crystal handmade
	Height: 365 mm Capacity: 1410 ccm Design: 2010	Height: 365 mm Capacity: 1430 ccm Design: 2010	Height: 365 mm Capacity: 1210 ccm Design: 2010	Height: 365 mm Capacity: 1410 ccm Design: 2010
PACKAGING	Pieces/Bill unit: 1	Pieces/Bill unit: 1	Pieces/Bill unit: 1	Pieces/Bill unit: 1
TYPE AND QUANTITY	Bill units/MP: 1	Bill units/MP: 1	Bill units/MP: 1	Bill units/MP: 1
BILL UNIT	Length: 172 mm	Length: 172 mm	Length: 172 mm	Length: 172 mm
DIMENSIONS	Width: 172 mm	Width: 172 mm	Width: 172 mm	Width: 172 mm
	Height: 476 mm	Height: 476 mm	Height: 476 mm	Height: 476 mm
	Weight: 1000 gr	Weight: 990 gr	Weight: 990 gr	Weight: 1000 gr
MASTERPACK	Length: 177 mm	Length: 177 mm	Length: 177 mm	Length: 177 mm
DIMENSIONS	Width: 177 mm	Width: 177 mm	Width: 177 mm	Width: 177 mm
	Height: 477 mm	Height: 477 mm	Height: 477 mm	Height: 477 mm
	Weight: 1131 gr	Weight: 1121 gr	Weight: 1121 gr	Weight: 1131 gr
EURO PALLET	Bill units/pallet: 90	Bill units/pallet: 90	Bill units/pallet: 90	Bill units/pallet: 90
	Bill units/layer: 9	Bill units/layer: 9	Bill units/layer: 9	Bill units/layer: 9
	Layers/pallet: 10	Layers/pallet: 10	Layers/pallet: 10	Layers/pallet: 10
CONTAINER PALLET	Bill units/pallet: 182	Bill units/pallet: 182	Bill units/pallet: 182	Bill units/pallet: 182
HIGH CUBE	Bill units/layer: 14	Bill units/layer: 14	Bill units/layer: 14	Bill units/layer: 14
	Layers/pallet: 13	Layers/pallet: 13	Layers/pallet: 13	Layers/pallet: 13
EAN				
BILL UNIT	9 006206 212934	9 006206 212941	9 006206 212958	9 006206 212989



Black Tie Touch Decanter
Red



Black Tie Bliss Decanter
Red



Cornetto Mini Decanter



Ultra Decanter

ITEM	Item no.: 2009/0253	Item no.: 2009/0353	Item no.: 1977/14	Item no.: 2400/14
	fine crystal handmade	fine crystal handmade	fine crystal handmade	fine crystal handmade
	Height: 365 mm	Height: 365 mm	Height: 282 mm	Height: 225 mm
	Capacity: 1430 ccm	Capacity: 1210 ccm	Capacity: 720 ccm	Capacity: 1230 ccm
	Design: 2010	Design: 2010	Design: 2019	Design: 1994
PACKAGING	Pieces/Bill unit: 1	Pieces/Bill unit: 1	Pieces/Bill unit: 1	Pieces/Bill unit: 1
TYPE AND QUANTITY	Bill units/MP: 1	Bill units/MP: 1	Bill units/MP: 1	Bill units/MP: 1
BILL UNIT	Length: 172 mm	Length: 172 mm	Length: 291 mm	Length: 290 mm
DIMENSIONS	Width: 172 mm	Width: 172 mm	Width: 198 mm	Width: 290 mm
	Height: 476 mm	Height: 476 mm	Height: 224 mm	Height: 308 mm
	Weight: 990 gr	Weight: 990 gr	Weight: 625 gr	Weight: 1101 gr
MASTERPACK	Length: 177 mm	Length: 177 mm	Length: -	Length: 299 mm
DIMENSIONS	Width: 177 mm	Width: 177 mm	Width: -	Width: 299 mm
	Height: 477 mm	Height: 477 mm	Height: -	Height: 314 mm
	Weight: 1121 gr	Weight: 1121 gr	Weight: -	Weight: 1240 gr
EURO PALLET	Bill units/pallet: 90	Bill units/pallet: 90	Bill units/pallet: 128	Bill units/pallet: 48
	Bill units/layer: 9	Bill units/layer: 9	Bill units/layer: 16	Bill units/layer: 8
	Layers/pallet: 10	Layers/pallet: 10	Layers/pallet: 8	Layers/pallet: 6
CONTAINER PALLET	Bill units/pallet: 182	Bill units/pallet: 182	Bill units/pallet: 224	Bill units/pallet: 84
HIGH CUBE	Bill units/layer: 14	Bill units/layer: 14	Bill units/layer: 28	Bill units/layer: 12
	Layers/pallet: 13	Layers/pallet: 13	Layers/pallet: 8	Layers/pallet: 7
EAN BILL UNIT				

DECANTERS



Limited Editions: TG reserves the right to offer glassware marked as "Limited Edition" in a certain amount and for a certain time period and under certain allocation criteria to Customer.





Decanter „O“
Single



Mosel Decanter



Medoc Decanter

ITEM	Item no.: 1414/13 fine crystal handmade Height: 225 mm Capacity: 980 ccm Design: 2006	Item no.: 2019/03 fine crystal handmade Height: 290 mm Capacity: 1150 ccm Design: 2019	Item no.: 2019/04 fine crystal handmade Height: 290 mm Capacity: 1110 ccm Design: 2019
PACKAGING TYPE AND QUANTITY	Pieces/Bill unit: 1 Bill units/MP: 1	Pieces/Bill unit: 1 Bill units/MP: 1	Pieces/Bill unit: 1 Bill units/MP: 1
BILL UNIT DIMENSIONS	Length: 290 mm Width: 130 mm Height: 130 mm Weight: 595 gr	Length: 172 mm Width: 172 mm Height: 476 mm Weight: 842 gr	Length: 172 mm Width: 172 mm Height: 476 mm Weight: 845 gr
MASTERPACK DIMENSIONS	Length: - Width: - Height: - Weight: -	Length: 177 mm Width: 177 mm Height: 477 mm Weight: 973 gr	Length: 177 mm Width: 177 mm Height: 477 mm Weight: 976 gr
EURO PALLET	Bill units/pallet: 280 Bill units/layer: 20 Layers/pallet: 14	Bill units/pallet: 90 Bill units/layer: 9 Layers/pallet: 10	Bill units/pallet: 90 Bill units/layer: 9 Layers/pallet: 10
CONTAINER PALLET HIGH CUBE	Bill units/pallet: 527 Bill units/layer: 31 Layers/pallet: 17	Bill units/pallet: 182 Bill units/layer: 14 Layers/pallet: 13	Bill units/pallet: 182 Bill units/layer: 14 Layers/pallet: 13
EAN BILL UNIT	 9 006206 311293	 9 006206 313266	 9 006206 313273





Macon Decanter



Marne Decanter



Margaux Decanter

ITEM	Item no.: 2017/01 fine crystal handmade	Item no.: 2017/02 fine crystal handmade	Item no.: 2017/03 fine crystal handmade
	Height: 210 mm Capacity: 1425 ccm Design: 2017	Height: 200 mm Capacity: 1894 ccm Design: 2017	Height: 153 mm Capacity: 1425 ccm Design: 2017
PACKAGING	Pieces/Bill unit: 1	Pieces/Bill unit: 1	Pieces/Bill unit: 1
TYPE AND QUANTITY	Bill units/MP: 1	Bill units/MP: 1	Bill units/MP: 1
BILL UNIT	Length: 260 mm	Length: 260 mm	Length: 260 mm
DIMENSIONS	Width: 260 mm	Width: 260 mm	Width: 260 mm
	Height: 240 mm	Height: 240 mm	Height: 240 mm
	Weight: 668 gr	Weight: 668 gr	Weight: 668 gr
MASTERPACK	Length: 266 mm	Length: 266 mm	Length: 266 mm
DIMENSIONS	Width: 266 mm	Width: 266 mm	Width: 266 mm
	Height: 244 mm	Height: 244 mm	Height: 244 mm
	Weight: 883 gr	Weight: 883 gr	Weight: 883 gr
EURO PALLET	Bill units/pallet: 84	Bill units/pallet: 84	Bill units/pallet: 84
	Bill units/layer: 12	Bill units/layer: 12	Bill units/layer: 12
	Layers/pallet: 7	Layers/pallet: 7	Layers/pallet: 7
CONTAINER PALLET	Bill units/pallet: 144	Bill units/pallet: 144	Bill units/pallet: 144
HIGH CUBE	Bill units/layer: 16	Bill units/layer: 16	Bill units/layer: 16
	Layers/pallet: 9	Layers/pallet: 9	Layers/pallet: 9
EAN BILL UNIT	 9 006206 312733	 9 006206 312740	 9 006206 312757





DECANTERS

NEW



Mosel Magnum Decanter







Decanter Mosel Machine-Made



Cabernet Magnum Decanter



Cabernet Decanter

ITEM	Item no.: 1419/23 fine crystal machine-made	Item no.: 1419/03 fine crystal machine-made	Item no.: 1440/26 fine crystal machine-made	Item no.: 1440/13 fine crystal machine-made
	Height: 285 mm Capacity: 2087 ccm Design: 2023	Height: 285 mm Capacity: 1320 ccm Design: 2022	Height: 270 mm Capacity: 1700 ccm Design: 2004	Height: 230 mm Capacity: 1050 ccm Design: 2004
PACKAGING TYPE AND QUANTITY	Pieces/Bill unit: 1 Bill units/MP: 2	Pieces/Bill unit: 1 Bill units/MP: 4	Pieces/Bill unit: 1 Bill units/MP: 1	Pieces/Bill unit: 1 Bill units/MP: 4
BILL UNIT DIMENSIONS	Length: 140 mm Width: 140 mm Height: 294 mm Weight: 612 gr	Length: 115 mm Width: 115 mm Height: 306 mm Weight: 461 gr	Length: 291 mm Width: 198 mm Height: 224 mm Weight: 703 gr	Length: 130 mm Width: 130 mm Height: 240 mm Weight: 377 gr
MASTERPACK DIMENSIONS	Length: 291 mm Width: 148 mm Height: 310 mm Weight: 1358 gr	Length: 239 mm Width: 239 mm Height: 317 mm Weight: 2016 gr	Length: - Width: - Height: - Weight: -	Length: 266 mm Width: 266 mm Height: 250 mm Weight: 1737 gr
EURO PALLET	Bill units/pallet: 240 Bill units/layer: 40 Layers/pallet: 6	Bill units/pallet: 240 Bill units/layer: 48 Layers/pallet: 5	Bill units/pallet: 128 Bill units/layer: 16 Layers/pallet: 8	Bill units/pallet: 336 Bill units/layer: 48 Layers/pallet: 7
CONTAINER PALLET HIGH CUBE	Bill units/pallet: 392 Bill units/layer: 56 Layers/pallet: 7	Bill units/pallet: 560 Bill units/layer: 80 Layers/pallet: 7	Bill units/pallet: 224 Bill units/layer: 28 Layers/pallet: 8	Bill units/pallet: 576 Bill units/layer: 64 Layers/pallet: 9
EAN BILL UNIT	 9 006206 325818	 9 006206 322909	 9 006206 311132	 9 006206 311118





Syrah Decanter







RIEDEL Apple NY Decanter



Performance Decanter



Merlot Decanter

ITEM	Item no.: fine crystal machine-made	1480/13	Item no.: fine crystal machine-made	1460/13	Item no.: fine crystal machine-made	1490/13	Item no.: fine crystal machine-made	1440/14
	Height:	245 mm	Height:	195 mm	Height:	245 mm	Height:	240 mm
	Capacity:	1040 ccm	Capacity:	1500 ccm	Capacity:	1040 ccm	Capacity:	970 ccm
	Design:	2017	Design:	2014	Design:	2018	Design:	2004
PACKAGING	Pieces/Bill unit:	1	Pieces/Bill unit:	1	Pieces/Bill unit:	1	Pieces/Bill unit:	1
TYPE AND QUANTITY	Bill units/MP:	4	Bill units/MP:	4	Bill units/MP:	4	Bill units/MP:	4
BILL UNIT	Length:	145 mm	Length:	140 mm	Length:	145 mm	Length:	121 mm
DIMENSIONS	Width:	145 mm	Width:	140 mm	Width:	145 mm	Width:	121 mm
	Height:	256 mm	Height:	208 mm	Height:	256 mm	Height:	251 mm
	Weight:	402 gr	Weight:	354 gr	Weight:	392 gr	Weight:	352 gr
MASTERPACK	Length:	296 mm	Length:	294 mm	Length:	296 mm	Length:	250 mm
DIMENSIONS	Width:	296 mm	Width:	294 mm	Width:	296 mm	Width:	250 mm
	Height:	267 mm	Height:	217 mm	Height:	267 mm	Height:	261 mm
	Weight:	1859 gr	Weight:	1651 gr	Weight:	1796 gr	Weight:	1600 gr
EURO PALLET	Bill units/pallet:	224	Bill units/pallet:	312	Bill units/pallet:	224	Bill units/pallet:	336
	Bill units/layer:	32	Bill units/layer:	52	Bill units/layer:	32	Bill units/layer:	48
	Layers/pallet:	7	Layers/pallet:	6	Layers/pallet:	7	Layers/pallet:	7
CONTAINER PALLET	Bill units/pallet:	448	Bill units/pallet:	504	Bill units/pallet:	448	Bill units/pallet:	576
HIGH CUBE	Bill units/layer:	64	Bill units/layer:	72	Bill units/layer:	64	Bill units/layer:	64
	Layers/pallet:	7	Layers/pallet:	7	Layers/pallet:	7	Layers/pallet:	9
EAN	 9 006206 525881		 9 006206 311811		 9 006206 528226		 9 006206 513215	
BILL UNIT								

DECANTERS







Polishing Cloths



Microfiber Polishing Cloth



Bottle Cleaner

ITEM	Item no.:	5010/07	Item no.:	0010/07	Item no.:	0010/05
	-	-	-	-	-	-
	Height:	-	Height:	-	Height:	-
	Capacity:	-	Capacity:	-	Capacity:	-
	Design:	2010	Design:	2006	Design:	2001
PACKAGING	Pieces/Bill unit:	20	Pieces/Bill unit:	1	Pieces/Bill unit:	1
TYPE AND QUANTITY	Bill units/MP:	1	Bill units/MP:	-	Bill units/MP:	12
BILL UNIT	Length:	285 mm	Length:	-	Length:	50 mm
DIMENSIONS	Width:	186 mm	Width:	-	Width:	42 mm
	Height:	6 mm	Height:	-	Height:	35 mm
	Weight:	2206 gr	Weight:	-	Weight:	93 gr
MASTERPACK	Length:	297 mm	Length:	-	Length:	215 mm
DIMENSIONS	Width:	228 mm	Width:	-	Width:	155 mm
	Height:	182 mm	Height:	-	Height:	52 mm
	Weight:	2379 gr	Weight:	-	Weight:	1119 gr
EURO PALLET	Bill units/pallet:	2600	Bill units/pallet:	4320	Bill units/pallet:	11664
	Bill units/layer:	260	Bill units/layer:	720	Bill units/layer:	324
	Layers/pallet:	10	Layers/pallet:	6	Layers/pallet:	36
CONTAINER PALLET	Bill units/pallet:	4400	Bill units/pallet:	9600	Bill units/pallet:	19536
HIGH CUBE	Bill units/layer:	440	Bill units/layer:	1200	Bill units/layer:	444
	Layers/pallet:	10	Layers/pallet:	8	Layers/pallet:	44
EAN	 9 006206 212798		 9 006206 212781		 9 006206 212613	
BILL UNIT						

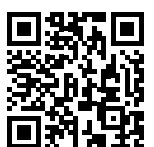







Bottle Bag



Carrying Bag

ITEM	Item no.: 5000/22	Item no.: 5000/04
	-	-
	-	-
	Height: 320 mm	Height: -
	Capacity: -	Capacity: -
	Design: 2022	Design: 2021
PACKAGING	Pieces/Bill unit: 1	Pieces/Bill unit: 1
TYPE AND QUANTITY	Bill units/MP: -	Bill units/MP: 4
BILL UNIT	Length: -	Length: 550 mm
DIMENSIONS	Width: -	Width: 116 mm
	Height: -	Height: 300 mm
	Weight: -	Weight: 1200 gr
MASTERPACK	Length: -	Length: 570 mm
DIMENSIONS	Width: -	Width: 480 mm
	Height: -	Height: 320 mm
	Weight: -	Weight: 5800 gr
EURO PALLET	Bill units/pallet: -	Bill units/pallet: 40
	Bill units/layer: -	Bill units/layer: 8
	Layers/pallet: -	Layers/pallet: 5
CONTAINER PALLET	Bill units/pallet: -	Bill units/pallet: 112
HIGH CUBE	Bill units/layer: -	Bill units/layer: 16
	Layers/pallet: -	Layers/pallet: 7
EAN		
BILL UNIT	9 006206 323456	9 006206 322831

While supplies last.







RIEDEL Veritas Cabernet/Merlot
Value Gift Pack - Pay 6 Get 8



RIEDEL Veritas Champagne Glass
Value Gift Pack - Pay 6 Get 8

ITEM	Item no.:	7449/0	Item no.:	7449/28
	fine crystal machine-made		fine crystal machine-made	
	Height/glass:	235 mm	Height/glass:	235 mm
	Capacity/glass:	625 ccm	Capacity/glass:	445 ccm
	Design:	2019	Design:	2019
PACKAGING	Pieces/Bill unit:	8	Pieces/Bill unit:	8
TYPE AND QUANTITY	Bill units/MP:	1	Bill units/MP:	1
BILL UNIT	Length:	488 mm	Length:	488 mm
DIMENSIONS	Width:	249 mm	Width:	249 mm
	Height:	290 mm	Height:	290 mm
	Weight:	2260 gr	Weight:	2180 gr
MASTERPACK	Length:	491 mm	Length:	491 mm
DIMENSIONS	Width:	257 mm	Width:	257 mm
	Height:	299 mm	Height:	299 mm
	Weight:	2480 gr	Weight:	2400 gr
EURO PALLET	Bill units/pallet:	42	Bill units/pallet:	42
	Bill units/layer:	6	Bill units/layer:	6
	Layers/pallet:	7	Layers/pallet:	7
CONTAINER PALLET	Bill units/pallet:	72	Bill units/pallet:	72
HIGH CUBE	Bill units/layer:	8	Bill units/layer:	8
	Layers/pallet:	9	Layers/pallet:	9
EAN BILL UNIT	 9 006206 524259		 9 006206 524310	







Cabernet/Merlot
Value Gift Pack - Pay 3 Get 4



Viognier/Chardonnay
Value Gift Pack - Pay 3 Get 4

ITEM	Item no.: 5416/0 fine crystal premium machine-made Height/glass: 225 mm Capacity/glass: 610 ccm Design: 2022	Item no.: 5416/05 fine crystal premium machine-made Height/glass: 198 mm Capacity/glass: 350 ccm Design: 2022
PACKAGING TYPE AND QUANTITY	Pieces/Bill unit: 4 Bill units/MP: 2	Pieces/Bill unit: 4 Bill units/MP: 2
BILL UNIT DIMENSIONS	Length: 225 mm Width: 225 mm Height: 274 mm Weight: 1123 gr	Length: 225 mm Width: 225 mm Height: 274 mm Weight: 1023 gr
MASTERPACK DIMENSIONS	Length: 459 mm Width: 236 mm Height: 287 mm Weight: 2525 gr	Length: 459 mm Width: 236 mm Height: 287 mm Weight: 2325 gr
EURO PALLET	Bill units/pallet: 84 Bill units/layer: 14 Layers/pallet: 6	Bill units/pallet: 84 Bill units/layer: 14 Layers/pallet: 6
CONTAINER PALLET HIGH CUBE	Bill units/pallet: 160 Bill units/layer: 20 Layers/pallet: 8	Bill units/pallet: 160 Bill units/layer: 20 Layers/pallet: 8
EAN BILL UNIT	 9 006206 528806	 9 006206 528813

VALUE GIFT PACKS





VINUM Cabernet Sauvignon/Merlot
Value Gift Pack - Pay 6 Get 8



VINUM Viognier/Chardonnay
Value Gift Pack - Pay 6 Get 8

ITEM	Item no.:	7416/0	Item no.:	7416/05
	fine crystal		fine crystal	
	machine-made		machine-made	
	Height/glass:	225 mm	Height/glass:	198 mm
	Capacity/glass:	610 ccm	Capacity/glass:	350 ccm
	Design:	2015	Design:	2015
PACKAGING	Pieces/Bill unit:	8	Pieces/Bill unit:	8
TYPE AND QUANTITY	Bill units/MP:	1	Bill units/MP:	1
BILL UNIT	Length:	447 mm	Length:	447 mm
DIMENSIONS	Width:	236 mm	Width:	236 mm
	Height:	282 mm	Height:	282 mm
	Weight:	2347 gr	Weight:	2035 gr
MASTERPACK	Length:	457 mm	Length:	457 mm
DIMENSIONS	Width:	255 mm	Width:	255 mm
	Height:	306 mm	Height:	306 mm
	Weight:	2690 gr	Weight:	2366 gr
EURO PALLET	Bill units/pallet:	42	Bill units/pallet:	42
	Bill units/layer:	7	Bill units/layer:	7
	Layers/pallet:	6	Layers/pallet:	6
CONTAINER PALLET	Bill units/pallet:	70	Bill units/pallet:	70
HIGH CUBE	Bill units/layer:	10	Bill units/layer:	10
	Layers/pallet:	7	Layers/pallet:	7
EAN	 9 006206 515066		 9 006206 515073	
BILL UNIT				





VINUM + Gift
2x Cabernet Sauvignon + 1x Polishing Cloth

ITEM	Item no.: 6416/0-POL fine crystal machine-made
	Height/glass: 225 mm Capacity/glass: 610 ccm Design: 2021
PACKAGING TYPE AND QUANTITY	Pieces/Bill unit: 2 Bill units/MP: 4
BILL UNIT DIMENSIONS	Length: 227 mm Width: 116 mm Height: 275 mm Weight: 612 gr
MASTERPACK DIMENSIONS	Length: 469 mm Width: 235 mm Height: 285 mm Weight: 2752 gr
EURO PALLET	Bill units/pallet: 168 Bill units/layer: 28 Layers/pallet: 6
CONTAINER PALLET HIGH CUBE	Bill units/pallet: 320 Bill units/layer: 40 Layers/pallet: 8
EAN BILL UNIT	 9 006206 321353







Ouverture + Gift
6x Magnum + 1x RIEDEL Apple Decanter



Ouverture White Wine / Magnum / Champagne Glass
Value Gift Pack - Pay 9 Get 12

ITEM	Item no.:	5408/35	Item no.:	5408/93
	fine crystal		fine crystal	
	machine-made		machine-made	
	Height/glass:	-	Height/glass:	-
	Capacity/glass:	-	Capacity/glass:	-
	Design:	2015	Design:	2017
PACKAGING	Pieces/Bill unit:	7	Pieces/Bill unit:	12
TYPE AND QUANTITY	Bill units/MP:	1	Bill units/MP:	1
BILL UNIT	Length:	475 mm	Length:	436 mm
DIMENSIONS	Width:	228 mm	Width:	335 mm
	Height:	245 mm	Height:	250 mm
	Weight:	2070 gr	Weight:	2631 gr
	MASTERPACK	Length:	484 mm	Length:
DIMENSIONS	Width:	237 mm	Width:	345 mm
	Height:	254 mm	Height:	263 mm
	Weight:	2260 gr	Weight:	3010 gr
	EURO PALLET	Bill units/pallet:	49	Bill units/pallet:
	Bill units/layer:	7	Bill units/layer:	5
	Layers/pallet:	7	Layers/pallet:	7
CONTAINER PALLET	Bill units/pallet:	90	Bill units/pallet:	56
HIGH CUBE	Bill units/layer:	10	Bill units/layer:	7
	Layers/pallet:	9	Layers/pallet:	8
	EAN		EAN	
BILL UNIT	9 006206 524389		9 006206 526079	





VALUE GIFT PACKS



Extreme Cabernet
Value Gift Pack - Pay 3 Get 4



Extreme Pinot Noir
Value Gift Pack - Pay 3 Get 4

ITEM	Item no.:	4411/0	Item no.:	4411/07
	fine crystal		fine crystal	
	machine-made		machine-made	
	Height/glass:	247 mm	Height/glass:	243 mm
PACKAGING TYPE AND QUANTITY	Capacity/glass:	800 ccm	Capacity/glass:	770 ccm
	Design:	2018	Design:	2018
	Pieces/Bill unit:	4	Pieces/Bill unit:	4
	Bill units/MP:	2	Bill units/MP:	2
BILL UNIT DIMENSIONS	Length:	270 mm	Length:	270 mm
	Width:	263 mm	Width:	263 mm
	Height:	278 mm	Height:	278 mm
	Weight:	1367 gr	Weight:	1367 gr
MASTERPACK DIMENSIONS	Length:	534 mm	Length:	534 mm
	Width:	282 mm	Width:	282 mm
	Height:	296 mm	Height:	296 mm
	Weight:	3103 gr	Weight:	3103 gr
EURO PALLET	Bill units/pallet:	48	Bill units/pallet:	48
	Bill units/layer:	8	Bill units/layer:	8
	Layers/pallet:	6	Layers/pallet:	6
CONTAINER PALLET HIGH CUBE	Bill units/pallet:	112	Bill units/pallet:	112
	Bill units/layer:	16	Bill units/layer:	16
	Layers/pallet:	7	Layers/pallet:	7
EAN BILL UNIT	 9 006206 526758		 9 006206 526765	





Extreme Riesling
Value Gift Pack - Pay 3 Get 4



Extreme Rosé Champagne Glass/Rosé Wine
Value Gift Pack - Pay 3 Get 4

ITEM	Item no.: 4411/15 fine crystal machine-made Height/glass: 240 mm Capacity/glass: 490 ccm Design: 2018	Item no.: 4411/55 fine crystal machine-made Height/glass: 230 mm Capacity/glass: 322 ccm Design: 2018
PACKAGING TYPE AND QUANTITY	Pieces/Bill unit: 4 Bill units/MP: 2	Pieces/Bill unit: 4 Bill units/MP: 2
BILL UNIT DIMENSIONS	Length: 270 mm Width: 263 mm Height: 278 mm Weight: 1263 gr	Length: 270 mm Width: 263 mm Height: 278 mm Weight: 1215 gr
MASTERPACK DIMENSIONS	Length: 534 mm Width: 282 mm Height: 296 mm Weight: 2895 gr	Length: 534 mm Width: 282 mm Height: 296 mm Weight: 2799 gr
EURO PALLET	Bill units/pallet: 48 Bill units/layer: 8 Layers/pallet: 6	Bill units/pallet: 48 Bill units/layer: 8 Layers/pallet: 6
CONTAINER PALLET HIGH CUBE	Bill units/pallet: 112 Bill units/layer: 16 Layers/pallet: 7	Bill units/pallet: 112 Bill units/layer: 16 Layers/pallet: 7
EAN BILL UNIT	 9 006206 526802	 9 006206 526772

VALUE GIFT PACKS





Cabernet
Value Gift Pack - Pay 3 Get 4



Riesling
Value Gift Pack - Pay 3 Get 4

ITEM	Item no.:	7414/0	Item no.:	7414/15
	fine crystal machine-made		fine crystal machine-made	
	Height/glass:	121 mm	Height/glass:	108 mm
PACKAGING TYPE AND QUANTITY	Capacity/glass:	600 ccm	Capacity/glass:	375 ccm
	Design:	2022	Design:	2022
	Pieces/Bill unit:	4	Pieces/Bill unit:	4
BILL UNIT DIMENSIONS	Bill units/MP:	4	Bill units/MP:	4
	Length:	201 mm	Length:	170 mm
	Width:	201 mm	Width:	170 mm
	Height:	131 mm	Height:	118 mm
MASTERPACK DIMENSIONS	Weight:	596 gr	Weight:	516 gr
	Length:	412 mm	Length:	346 mm
	Width:	213 mm	Width:	177 mm
	Height:	281 mm	Height:	245 mm
EURO PALLET	Weight:	2585 gr	Weight:	2210 gr
	Bill units/pallet:	168	Bill units/pallet:	336
	Bill units/layer:	28	Bill units/layer:	48
CONTAINER PALLET HIGH CUBE	Layers/pallet:	6	Layers/pallet:	7
	Bill units/pallet:	384	Bill units/pallet:	648
	Bill units/layer:	48	Bill units/layer:	72
EAN BILL UNIT	Layers/pallet:	8	Layers/pallet:	9





Viognier/Chardonnay
Value Gift Pack - Pay 3 Get 4

ITEM	Item no.: 7414/05 fine crystal machine-made
	Height/glass: 96 mm Capacity/glass: 320 ccm Design: 2022
PACKAGING TYPE AND QUANTITY	Pieces/Bill unit: 4 Bill units/MP: 4
BILL UNIT DIMENSIONS	Length: 170 mm Width: 170 mm Height: 118 mm Weight: 500 gr
MASTERPACK DIMENSIONS	Length: 339 mm Width: 175 mm Height: 222 mm Weight: 2167 gr
EURO PALLET	Bill units/pallet: 448 Bill units/layer: 56 Layers/pallet: 8
CONTAINER PALLET HIGH CUBE	Bill units/pallet: 840 Bill units/layer: 84 Layers/pallet: 10
EAN BILL UNIT	 9 006206 522255





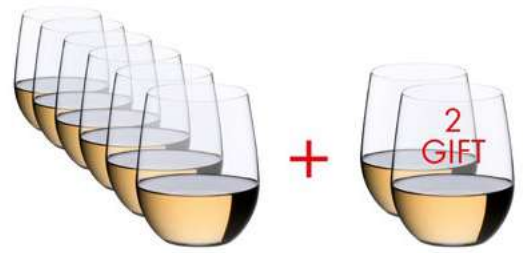

O Wine Tumbler Cabernet/Merlot
Value Gift Pack - Pay 6 Get 8



O Wine Tumbler Viognier/Chardonnay
Value Gift Pack - Pay 6 Get 8

ITEM	Item no.:	5414/80	Item no.:	5414/85
	fine crystal machine-made		fine crystal machine-made	
	Height/glass:	121 mm	Height/glass:	96 mm
PACKAGING TYPE AND QUANTITY	Capacity/glass:	600 ccm	Capacity/glass:	320 ccm
	Design:	2007	Design:	2007
	Pieces/Bill unit:	8	Pieces/Bill unit:	8
BILL UNIT DIMENSIONS	Bill units/MP:	4	Bill units/MP:	4
	Length:	395 mm	Length:	332 mm
	Width:	199 mm	Width:	166 mm
	Height:	129 mm	Height:	104 mm
MASTERPACK DIMENSIONS	Weight:	1157 gr	Weight:	955 gr
	Length:	411 mm	Length:	349 mm
	Width:	416 mm	Width:	344 mm
	Height:	280 mm	Height:	230 mm
EURO PALLET	Weight:	5145 gr	Weight:	4180 gr
	Bill units/pallet:	96	Bill units/pallet:	192
	Bill units/layer:	24	Bill units/layer:	24
CONTAINER PALLET HIGH CUBE	Layers/pallet:	4	Layers/pallet:	8
	Bill units/pallet:	200	Bill units/pallet:	360
	Bill units/layer:	40	Bill units/layer:	36
EAN BILL UNIT	Layers/pallet:	5	Layers/pallet:	10
				







8 Wine Tumbler Cabernet/Merlot + Viognier/Chardonnay
Value Gift Pack - Pay 6 Get 8



4x Cabernet/Merlot + 1x Syrah Decanter
O + Gift

ITEM	Item no.: 5414/50 fine crystal machine-made	Item no.: 5414/30 fine crystal machine-made
	Height/glass: - Capacity/glass: - Design: 2009	Height/glass: - Capacity/glass: - Design: 2011
PACKAGING TYPE AND QUANTITY	Pieces/Bill unit: 8 Bill units/MP: 4	Pieces/Bill unit: 5 Bill units/MP: 2
BILL UNIT DIMENSIONS	Length: 395 mm Width: 199 mm Height: 129 mm Weight: 1155 gr	Length: 268 mm Width: 207 mm Height: 268 mm Weight: 1228 gr
MASTERPACK DIMENSIONS	Length: 411 mm Width: 416 mm Height: 280 mm Weight: 5110 gr	Length: 421 mm Width: 278 mm Height: 282 mm Weight: 2782 gr
EURO PALLET	Bill units/pallet: 96 Bill units/layer: 24 Layers/pallet: 4	Bill units/pallet: 72 Bill units/layer: 12 Layers/pallet: 6
CONTAINER PALLET HIGH CUBE	Bill units/pallet: 200 Bill units/layer: 40 Layers/pallet: 5	Bill units/pallet: 144 Bill units/layer: 18 Layers/pallet: 8
EAN BILL UNIT	 9 006206 515240	 9 006206 516216

VALUE GIFT PACKS







Red Wine Set



White Wine Set

ITEM	Item no.:	5441/0	Item no.:	5441/15
	fine crystal		fine crystal	
	machine-made		machine-made	
	Height/glass:	247 mm	Height/glass:	240 mm
	Capacity/glass:	800 ccm	Capacity/glass:	490 ccm
	Design:	2018	Design:	2018
PACKAGING	Pieces/Bill unit:	4	Pieces/Bill unit:	4
TYPE AND QUANTITY	Bill units/MP:	4	Bill units/MP:	4
BILL UNIT	Length:	519 mm	Length:	519 mm
DIMENSIONS	Width:	134 mm	Width:	134 mm
	Height:	279 mm	Height:	279 mm
	Weight:	1382 gr	Weight:	1248 gr
MASTERPACK	Length:	551 mm	Length:	551 mm
DIMENSIONS	Width:	534 mm	Width:	534 mm
	Height:	294 mm	Height:	294 mm
	Weight:	6296 gr	Weight:	5760 gr
EURO PALLET	Bill units/pallet:	48	Bill units/pallet:	48
	Bill units/layer:	16	Bill units/layer:	16
	Layers/pallet:	3	Layers/pallet:	3
CONTAINER PALLET	Bill units/pallet:	112	Bill units/pallet:	112
HIGH CUBE	Bill units/layer:	16	Bill units/layer:	16
	Layers/pallet:	7	Layers/pallet:	7
EAN	 9 006206 528561		 9 006206 528288	
BILL UNIT				





Rosé Set



Prosecco Set

ITEM	Item no.:	5441/55	Item no.:	5441/85
	fine crystal machine-made		fine crystal machine-made	
	Height/glass:	230 mm	Height/glass:	222 mm
	Capacity/glass:	322 ccm	Capacity/glass:	305 ccm
	Design:	2018	Design:	2018
PACKAGING	Pieces/Bill unit:	4	Pieces/Bill unit:	4
TYPE AND QUANTITY	Bill units/MP:	4	Bill units/MP:	4
BILL UNIT	Length:	519 mm	Length:	519 mm
DIMENSIONS	Width:	134 mm	Width:	134 mm
	Height:	279 mm	Height:	279 mm
	Weight:	1230 gr	Weight:	1218 gr
	MASTERPACK	Length:	551 mm	Length:
DIMENSIONS	Width:	534 mm	Width:	534 mm
	Height:	294 mm	Height:	294 mm
	Weight:	5688 gr	Weight:	5640 gr
	EURO PALLET	Bill units/pallet:	48	Bill units/pallet:
	Bill units/layer:	16	Bill units/layer:	16
	Layers/pallet:	3	Layers/pallet:	3
CONTAINER PALLET	Bill units/pallet:	112	Bill units/pallet:	112
HIGH CUBE	Bill units/layer:	16	Bill units/layer:	16
	Layers/pallet:	7	Layers/pallet:	7
	EAN			
BILL UNIT				





Accanto



Accanto Pinot Noir



Accanto Red Wine

ITEM	Item no.:	0491/07	Item no.:	0491/0
	fine crystal		fine crystal	
	machine-made		machine-made	
	Height/glass:	215 mm	Height/glass:	224 mm
	Capacity/glass:	700 ccm	Capacity/glass:	560 ccm
	Design:	2018	Design:	2010
PACKAGING	Pieces/Bill unit:	4	Pieces/Bill unit:	4
TYPE AND QUANTITY	Bill units/MP:	2	Bill units/MP:	2
BILL UNIT	Length:	223 mm	Length:	185 mm
DIMENSIONS	Width:	223 mm	Width:	185 mm
	Height:	225 mm	Height:	232 mm
	Weight:	929 gr	Weight:	855 gr
MASTERPACK	Length:	464 mm	Length:	388 mm
DIMENSIONS	Width:	240 mm	Width:	202 mm
	Height:	242 mm	Height:	251 mm
	Weight:	2107 gr	Weight:	1906 gr
EURO PALLET	Bill units/pallet:	98	Bill units/pallet:	168
	Bill units/layer:	14	Bill units/layer:	24
	Layers/pallet:	7	Layers/pallet:	7
CONTAINER PALLET	Bill units/pallet:	180	Bill units/pallet:	270
HIGH CUBE	Bill units/layer:	20	Bill units/layer:	30
	Layers/pallet:	9	Layers/pallet:	9
EAN	 9 006206 531691		 9 006206 531677	
BILL UNIT				







Accanto White Wine



Accanto Champagen Flute

ITEM	Item no.: 0491/01 fine crystal machine-made Height/glass: 205 mm Capacity/glass: 340 ccm Design: 2018	Item no.: 0491/08 fine crystal machine-made Height/glass: 224 mm Capacity/glass: 290 ccm Design: 2018
PACKAGING TYPE AND QUANTITY	Pieces/Bill unit: 4 Bill units/MP: 2	Pieces/Bill unit: 4 Bill units/MP: 2
BILL UNIT DIMENSIONS	Length: 163 mm Width: 163 mm Height: 215 mm Weight: 708 gr	Length: 149 mm Width: 149 mm Height: 235 mm Weight: 672 gr
MASTERPACK DIMENSIONS	Length: 340 mm Width: 178 mm Height: 234 mm Weight: 1573 gr	Length: 308 mm Width: 160 mm Height: 248 mm Weight: 1474 gr
EURO PALLET	Bill units/pallet: 224 Bill units/layer: 28 Layers/pallet: 8	Bill units/pallet: 238 Bill units/layer: 34 Layers/pallet: 7
CONTAINER PALLET HIGH CUBE	Bill units/pallet: 378 Bill units/layer: 42 Layers/pallet: 9	Bill units/pallet: 294 Bill units/layer: 42 Layers/pallet: 7
EAN BILL UNIT	 9 006206 531684	 9 006206 324354







Accanto Wine Tumbler



Accanto Longdrink

ITEM	Item no.: 0491/41 fine crystal machine-made Height/glass: 118 mm Capacity/glass: 570 ccm Design: 2018	Item no.: 0490/04 fine crystal machine-made Height/glass: 151 mm Capacity/glass: 395 ccm Design: 2018
PACKAGING	Pieces/Bill unit: 4	Pieces/Bill unit: 4
TYPE AND QUANTITY	Bill units/MP: 2	Bill units/MP: 4
BILL UNIT	Length: 197 mm	Length: 326 mm
DIMENSIONS	Width: 197 mm	Width: 83 mm
	Height: 124 mm	Height: 157 mm
	Weight: 591 gr	Weight: 2172 gr
MASTERPACK	Length: 412 mm	Length: 348 mm
DIMENSIONS	Width: 214 mm	Width: 334 mm
	Height: 145 mm	Height: 171 mm
	Weight: 1343 gr	Weight: 8923 gr
EURO PALLET	Bill units/pallet: 182	Bill units/pallet: 192
	Bill units/layer: 14	Bill units/layer: 24
	Layers/pallet: 13	Layers/pallet: 8
CONTAINER PALLET	Bill units/pallet: 384	Bill units/pallet: 252
HIGH CUBE	Bill units/layer: 24	Bill units/layer: 36
	Layers/pallet: 16	Layers/pallet: 7
EAN		
BILL UNIT	9 006206 531707	9 006206 526994





Accanto Whisky Double Old Fashioned



Accanto Double Old Fashioned

ITEM	Item no.: 0491/05 fine crystal machine-made Height/glass: 102 mm Capacity/glass: 295 ccm Design: 2018	Item no.: 0491/02 fine crystal machine-made Height/glass: 94 mm Capacity/glass: 370 ccm Design: 2018
PACKAGING TYPE AND QUANTITY	Pieces/Bill unit: 4 Bill units/MP: 2	Pieces/Bill unit: 4 Bill units/MP: 4
BILL UNIT DIMENSIONS	Length: 172 mm Width: 172 mm Height: 110 mm Weight: 1712 gr	Length: 181 mm Width: 181 mm Height: 104 mm Weight: 1350 gr
MASTERPACK DIMENSIONS	Length: 354 mm Width: 183 mm Height: 124 mm Weight: 3548 gr	Length: 372 mm Width: 191 mm Height: 223 mm Weight: 5565 gr
EURO PALLET	Bill units/pallet: 264 Bill units/layer: 24 Layers/pallet: 11	Bill units/pallet: 384 Bill units/layer: 48 Layers/pallet: 8
CONTAINER PALLET HIGH CUBE	Bill units/pallet: 324 Bill units/layer: 36 Layers/pallet: 9	Bill units/pallet: 420 Bill units/layer: 60 Layers/pallet: 7
EAN BILL UNIT	 9 006206 325283	 9 006206 322763





Accanto Balloon Decanter

ITEM	Item no.: 0490/13 fine crystal machine-made
	Height: 245 mm Capacity: 1040 ccm Design: 2018
PACKAGING TYPE AND QUANTITY	Pieces/Bill unit: 1 Bill units/MP: 4
BILL UNIT DIMENSIONS	Length: 145 mm Width: 145 mm Height: 250 mm Weight: 439 gr
MASTERPACK DIMENSIONS	Length: 300 mm Width: 298 mm Height: 268 mm Weight: 2176 gr
EURO PALLET	Bill units/pallet: 224 Bill units/layer: 32 Layers/pallet: 7
CONTAINER PALLET HIGH CUBE	Bill units/pallet: 384 Bill units/layer: 48 Layers/pallet: 8
EAN BILL UNIT	 9 006206 517961

VIVANT



Vivant Red Wine



Vivant Pinot Noir

ITEM	Item no.: 0484/0	Item no.: 0484/07
	fine crystal machine-made	fine crystal machine-made
	Height/glass: 224 mm Capacity/glass: 560 ccm Design: 2018	Height/glass: 215 mm Capacity/glass: 700 ccm Design: 2018
PACKAGING TYPE AND QUANTITY	Pieces/Bill unit: 4 Bill units/MP: 2	Pieces/Bill unit: 4 Bill units/MP: 2
BILL UNIT DIMENSIONS	Length: 215 mm Width: 215 mm Height: 267 mm Weight: 1102 gr	Length: 255 mm Width: 255 mm Height: 260 mm Weight: 1193 gr
MASTERPACK DIMENSIONS	Length: 443 mm Width: 226 mm Height: 276 mm Weight: 2314 gr	Length: 519 mm Width: 264 mm Height: 270 mm Weight: 2446 gr
EURO PALLET	Bill units/pallet: 84 Bill units/layer: 14 Layers/pallet: 6	Bill units/pallet: 84 Bill units/layer: 12 Layers/pallet: 7
CONTAINER PALLET HIGH CUBE	Bill units/pallet: 190 Bill units/layer: 38 Layers/pallet: 5	Bill units/pallet: 128 Bill units/layer: 16 Layers/pallet: 8
EAN BILL UNIT	 9 006206 518517	 9 006206 518531





Vivant White Wine



Vivant Champagne Glass

ITEM	Item no.:	0484/01	Item no.:	0484/08
	fine crystal machine-made		fine crystal machine-made	
	Height/glass:	205 mm	Height/glass:	224 mm
	Capacity/glass:	340 ccm	Capacity/glass:	290 ccm
	Design:	2018	Design:	2018
PACKAGING TYPE AND QUANTITY	Pieces/Bill unit:	4	Pieces/Bill unit:	4
	Bill units/MP:	2	Bill units/MP:	2
BILL UNIT DIMENSIONS	Length:	163 mm	Length:	149 mm
	Width:	163 mm	Width:	149 mm
	Height:	215 mm	Height:	230 mm
	Weight:	756 gr	Weight:	660 gr
MASTERPACK DIMENSIONS	Length:	384 mm	Length:	354 mm
	Width:	220 mm	Width:	205 mm
	Height:	253 mm	Height:	268 mm
	Weight:	1812 gr	Weight:	1640 gr
EURO PALLET	Bill units/pallet:	140	Bill units/pallet:	168
	Bill units/layer:	20	Bill units/layer:	24
	Layers/pallet:	7	Layers/pallet:	7
CONTAINER PALLET HIGH CUBE	Bill units/pallet:	252	Bill units/pallet:	272
	Bill units/layer:	28	Bill units/layer:	34
	Layers/pallet:	9	Layers/pallet:	8
EAN BILL UNIT	 9 006206 518524		 9 006206 518548	







Vivant Longdrink



Vivant Whisky Double Old Fashioned

ITEM	Item no.: 0484/04 fine crystal machine-made	Item no.: 0484/05 fine crystal machine-made
	Height/glass: 151 mm	Height/glass: 102 mm
	Capacity/glass: 395 ccm	Capacity/glass: 295 ccm
	Design: 2018	Design: 2018
PACKAGING TYPE AND QUANTITY	Pieces/Bill unit: 4	Pieces/Bill unit: 4
	Bill units/MP: 2	Bill units/MP: 2
BILL UNIT DIMENSIONS	Length: 164 mm	Length: 172 mm
	Width: 164 mm	Width: 172 mm
	Height: 159 mm	Height: 110 mm
	Weight: 2154 gr	Weight: 1712 gr
MASTERPACK DIMENSIONS	Length: 335 mm	Length: 354 mm
	Width: 173 mm	Width: 183 mm
	Height: 173 mm	Height: 124 mm
	Weight: 4484 gr	Weight: 3548 gr
EURO PALLET	Bill units/pallet: 196	Bill units/pallet: 264
	Bill units/layer: 28	Bill units/layer: 24
	Layers/pallet: 7	Layers/pallet: 11
CONTAINER PALLET HIGH CUBE	Bill units/pallet: 252	Bill units/pallet: 324
	Bill units/layer: 42	Bill units/layer: 36
	Layers/pallet: 6	Layers/pallet: 9
EAN BILL UNIT	 9 006206 526222	 9 006206 526215





Vivant Balloon Decanter

ITEM	Item no.: 0484/23 fine crystal machine-made Height: 245 mm Capacity: 1040 ccm Design: 2018
PACKAGING TYPE AND QUANTITY	Pieces/Bill unit: 1 Bill units/MP: 2
BILL UNIT DIMENSIONS	Length: 145 mm Width: 145 mm Height: 253 mm Weight: 460 gr
MASTERPACK DIMENSIONS	Length: 345 mm Width: 200 mm Height: 315 mm Weight: 1140 gr
EURO PALLET	Bill units/pallet: 144 Bill units/layer: 24 Layers/pallet: 6
CONTAINER PALLET HIGH CUBE	Bill units/pallet: 252 Bill units/layer: 36 Layers/pallet: 7
EAN BILL UNIT	 9 006206 518609





TRADEMARK

Riedel

(1) *Riedel*

(2) **RIEDEL**

The RIEDEL TRADEMARK dates from the Art Nouveau period at the end of the nineteenth century, and was used for RIEDEL glassware made in Bohemia from 1890 to 1925. In 1996, to commemorate RIEDEL'S 240th anniversary, we reintroduced this trademark for all our handmade and hand-finished products. The distinctive RIEDEL signature is now featured on the base of all these products. This signature trademark (1) helps our customers to distinguish immediately between handmade, hand-finished products and those made by machine (2). Our machine-made products carry this trademark. The RIEDEL glass dynasty is built on the creative energies of a long line of glassmakers. The story begins in 1756 in Bohemia and continues right down to the united Europe of today, taking in on the way some of the most dramatic events in European history.

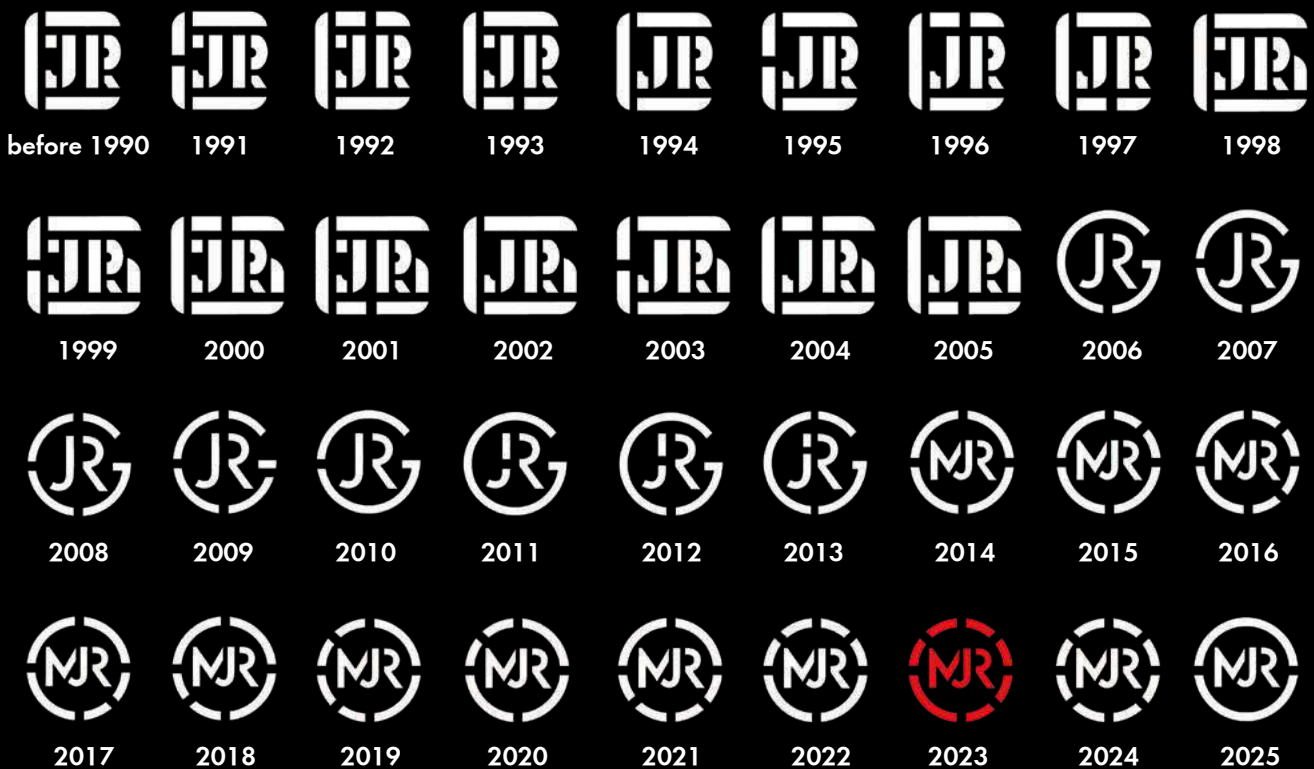

WINE CRITIC ROBERT M. PARKER JR. OF THE WINE ADVOCATE:

"The finest glasses for both technical and hedonistic purposes are those made by RIEDEL. The effect of these glasses on fine wine is profound. I cannot emphasize enough what a difference they make."

Michel Bettane, GUIDE BETTANE ET DESSEAUVE:

"It takes a great deal of effort for a talented winemaker to produce a good wine. These efforts can be ruined in no time if the wine is not served properly."

The quality of the glass plays a crucial role here and RIEDEL produces the largest range of high quality glasses, specifically fine-tuned to fit the predominant wine varieties of the planet. RIEDEL makes it possible to fully appreciate all the nuances of aromas and tastes from the best wines of the world."

TIME MAGAZINE:

"The RIEDEL family has never stamped its name on a single bottle of wine. But over the past 50 years, this Austrian clan of master glassmakers has done more to enhance the oenophile's pleasure than almost any winemaking dynasty."

ABOUT RIEDEL CRYSTAL

- RIEDEL CRYSTAL (established 1756) has been producing glass in the heart of Europe for over 265 years and for eleven generations.
- Family owned and operated by GEORG J. RIEDEL (10th generation) and MAXIMILIAN J. RIEDEL (11th generation).
- RIEDEL is recognized worldwide for designing and producing the highest quality glasses and decanters for the enjoyment of wine and spirits.
- Top-rated wineries and restaurants throughout the world use RIEDEL.
- RIEDEL produces collections for every lifestyle and price range, whether for critical wine evaluation, a picnic or dinner. There is a series for every wine lover.

AT RIEDEL, CONTENT COMMANDS SHAPE

Perfectly designed glassware enhances the aroma and the flavor of all aromatic beverages.

- In the late 1950's, CLAUS J. RIEDEL was the first person in history to introduce and develop wine-friendly stemware.
- Wine-friendly stemware translates and delivers the bouquet, taste, balance and finish of a wine to the senses.
- Based on this principal, RIEDEL introduced the concept of grape-specific glassware.

WHY SHAPE MATTERS

- Stemware consists of three parts: the bowl, stem and base.
- The height of the stem and the width of the base are part of the glass design (known as the architecture).
- Grape varietal specific stemware features finely-tuned glass bowls consisting of three variables: shape, size and rim diameter.
- Grape varietal specific stemware has to translate the "message" of wine to the human senses.

THERE ARE 4 SENSATIONS IN WINE:

- 1. Bouquet:** Grape varietal specific stemware is responsible for delivering the quality and intensity of the wine's aroma.
- 2. Texture:** Grape varietal specific stemware highlights the exciting and diverse styles of „mouthfeel“ in wine (watery, creamy, silky, velvety).
- 3. Flavor:** Grape varietal specific stemware creates a balanced interaction between the fruit, minerality, acidity and bitter components of a wine.
- 4. Finish:** Grape varietal specific stemware offers a pleasant, seamless, harmonious, and long lasting aftertaste.

THE ARCHITECTURE OF STEMWARE

Comprises three parts: bowl – stem – base.

The design (architecture or construction) of a stemmed glass must ensure that the size, height and width are in perfect harmony. The size of the bowl has to be in proportion to the height of the stem and the width of the base. Respecting the exact ratio between these dimensions ensures the glass is correctly and seamlessly proportioned. Table top “classics” are composed using the magic “golden architectural formula”. Early glass architecture, around 1920, took the lead, spearheaded by three Viennese architects (Loos, Hoffmann, Ertl). CLAUD J. RIEDEL’s designs from the late 1950’s, reestablished and took on this concept, which combined with influence from French and Irish classics resulted in stemware featuring this “construction”, which is so pleasing to the eye.

SERVING TO MAXIMIZE ENJOYMENT

- Glass hygiene: Serve beverages only in sparkling, clean, odorless glasses.
- Serving temperature: Do not over-chill white wines and sparkling wines; serve red wines below room temperature.
- Serving per glass: Maximum 3 to 6 oz/100 to 125 ml. Never over-pour the glass.
- The ample, gracious glass volume offers great wines the room to breathe and to express the unique message of the aroma.

CARING FOR YOUR RIEDEL CRYSTAL

Dishwasher safe for 1,000 plus cycles.

SELECTING THE RIGHT RIEDEL GLASS RIEDEL

Offers the option of either ‘varietal specific’ glasses, for dedicated wine lovers, or ‘wine friendly’ glasses, for informal wine drinkers. When choosing a grape varietal specific RIEDEL glass, consider that it is designed for, and performs at its best with, a specific type of wine. A grape varietal specific RIEDEL glass is a wine tool – ‘the key to wine’ – shaped to unlock the most elusive characteristics. Visit our Wine Glass Guide at RIEDEL.COM to identify the right glass for your wine.



Shiraz



Cabernet



Pinot Noir



Sauvignon Blanc



Riesling



Oaked Chardonnay



IS THERE ONE GLASS FOR ALL MY WINES?

The two most versatile shapes for red and white wines are the RIEDEL WINE FRIENDLY Magnum and the VINUM Riesling Grand Cru, but please remember: shape does matter for maximum intensity and total enjoyment of wine.

ONE SIZE FITS ALL? HOW CAN EACH SHAPE PROVIDE A UNIQUE EXPERIENCE FOR MY WINE?

- One glass is not ideal for all styles of wine; a wine's bouquet, taste, balance and finish are all affected by the shape of the glass it is consumed from.
- A wine will display completely different characteristics when served in different glasses.
- These differences can be so great, that when the same wine is served in several different glasses, even experienced wine connoisseurs believe that they are tasting as many different wines as there are glasses.
- RIEDEL has created shapes that specifically enhance a wine's harmony and highlight its unique characteristics.
- Grape varieties carry in their DNA unmistakable flavor profiles, which adds to the importance of selecting the appropriate glass.
- Wines have two, three or four flavor contributors which are associated with the fermentation process.



Two-flavor contributors: floral white wines – aroma and taste are dominated by fermented grape juice and the flavor of yeast.

RIESLING GRAND CRU
(13-3/8oz, 380ccm)



Three flavor contributors: oak-aged white wines – aroma and taste are dominated by fermented grape juice, the flavor of yeast, and oak influence (malolactic fermentation, gentle wood flavors combined with ageing and aeration).

**MONTRACHET/
CHARDONNAY**
(18-3/8oz, 520ccm)



Four flavor contributors: oak-aged red wines – aroma and taste are dominated by fermented grape juice, the flavor of yeast, maceration (fermentation of the skin and juice) and oak influence (malolactic fermentation, gentle wood flavors combined with ageing and aeration).

CABERNET
(30-3/8oz, 860ccm)

HAND-MADE PRODUCT

The origin of blown glassware dates back 2000 years. The Romans were the first to use this technique. At RIEDEL, in Kufstein, we produce hand-made and hand-finished crystal glassware. Each hand-made and hand-finished item is individually crafted/hand-finished by our master glassmakers. The expertise of these craftsmen guarantees that the quality of each glass meets the high standard for which our brand is known. Because of the hand-crafting/hand-finishing, small tolerances in the size and weight of each glass, tiny bubbles/imperfections and slight surface variations are a feature and an acceptable part of the process.

WHY SHOULD I USE A DECANTER? HOW WILL DECANTING ENHANCE MY WINE EXPERIENCE?

- **There are two reasons why we decant wines:**

1. Decant an older wine to separate it from its sediment.
2. Decant a younger wine to increase aeration, revealing more complexity, and opening up aromas and flavors.

- To enjoy young wines fully (up to 10 years for both red and white) consider opening them 8-12 hours prior to consumption for aeration, or decant the wine, as this shortens the aeration process.
- The main preservation element in wine is carbon dioxide, which is integrated with the wine during the first (= alcoholic) fermentation.
- Decanting reduces the amount of carbon dioxide and "matures" the wine, allowing the bouquet to develop faster.
- On the palate, decanted wine expresses higher levels of fruit in red wines and tends to integrate and smooth out tannins.
- When decanting young wines, turn the bottle directly into the decanter and let it splash into the vessel to maximise aeration.
- When decanting off the sediment of an old wine, slowly pour the wine into the decanter without allowing any sediment to leave the bottle.
- Suggest the customer considers trying the following exercise: *Using identical glasses, decant half the bottle and serve the other half directly from the bottle - then draw your own conclusion.*

CHRISTIAN MOUEIX, PRESIDENT OF THE NÉGOCIANT HOUSE ÉTABLISSEMENTS JEAN-PIERRE MOUEIX:

"I prefer to decant wines, both young and old. It is a sign of respect for old wines and a sign of confidence in young wines. Decanting old wines, just a few moments before they are served, helps to ensure that the wines' clarity and brilliance are not obscured by any deposit that may have developed over time. Decanting young wines several hours before they are served gives the wine a chance to bloom and attain a stage of development that normally requires years of ageing."



HANDMADE ITEMS

FOR COLOURED DECANTERS:

- minimum order of **25 decanters**
- all handmade decanters can be customized BUT limited edition colours can not be used, also metal colours like gold are not available
- No samples will be sent prior, note that colours cannot be predicted due to the fact, that this is depending on how thin the glass is blown.
- **50% Pre-payment** applies.
- For customized items, Riedel would ask that customers be amenable to accepting an **over or under production of 20%**.

Exception: Face to Face

- **minimum order 15 pieces WITHOUT** any upcharge.
- Process: please provide profile image, we will than do a drawing which has to be approved by the customer prior production.
- No samples will be available prior production.
- All customized items are excluded from promotions.



FOR DECANTER (SHAPES):

- existing shape, which is no longer in collection, (discontinued) can be reproduced
- a minimum order **of 50 decanters**
- prices on request

FOR CUSTOMIZED STEMWARE:

- Minimum order quantity: 175 pcs.
- 50% Pre-payment applies.
- RIEDEL Fatto A Mano only 2 colours.



CUSTOMIZED ,OCCHIO NERO' DECANTER

Pre-Arrangements

- Before order can be confirmed we need to get the logo from the customer in order to enable us to check whether it is feasible from a technical point of view.
- The line width must at least 2 mm at all parts of the logo.
- 50% Pre-payment applies.

Sampling

- Even if only one single sample is required we need a high quality stamp as per attached picture, therefore we have to charge € 500 for the sample.
- Stamp lasts for approx: 500 prints
- re-order of existing stamp motive € 300
- Sample has to be approved by the customer.

Basic parameters for orders

- Minimum order quantity: 50 pcs
- For customized items, Riedel would ask that customers be amenable to accepting an over or under production of 10%.



BLACK TIE
OCCHIO NERO
2009/04

Offer valid for alteration of logo etc. within the elliptical-shaped dent, variations of shape of dent have to be quoted separately.



Example for stamp

Embossing is possible in 3 basic shapes:

- 1 Circle of 60 mm
- 2 Small oval of 69 x 41 mm
- 3 Large oval of 76 x 50 mm

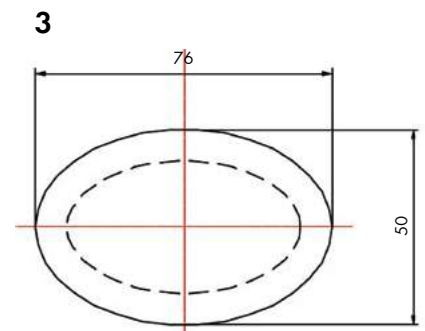
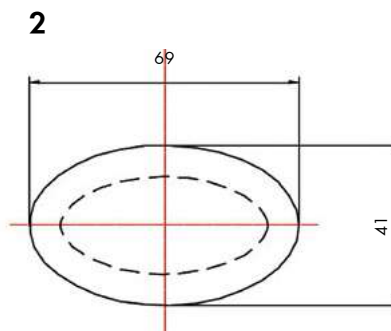
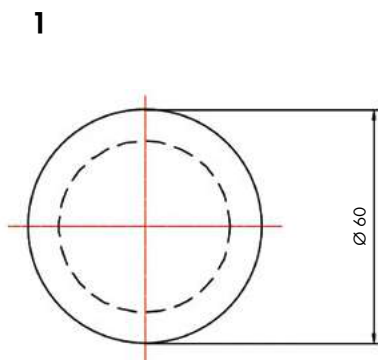

MICROFIBER POLISHING CLOTH

- Wash at boiling temperature (to kill bacteria) with odorless soap
- Should be machine washed at min. 170° F/60° C
- Never use fabric softener when rinsing your microfiber polishing cloth (avoids grease film on surface)



CARING FOR YOUR RIEDEL CRYSTAL

- All RIEDEL glasses are DISHWASHER SAFE for 1,000 plus cycles.
- To avoid stains: use soft water (low mineral content)
- To avoid scratches: Avoid glass contact with other glass or metal
- To remove stains: use white vinegar
- If available use a stemware rack

IF WASHING BY HAND

- Wash the glass under warm water (use detergent and rinse the glass carefully)
- Glass polishing: Use two polishing cloths, never hold the glass by the base to polish the bowl
- Stem snap: Occurs through mishandling = torque or bend pressure at the stem
- Storage: Avoid glass storage in kitchen cabinets which have strong aromas that translates into glass



FOR INFORMATION ON GLASS CARE
AND HOW TO WASH GLASSWARE,
VISIT RIEDEL.COM.

For a perfect result

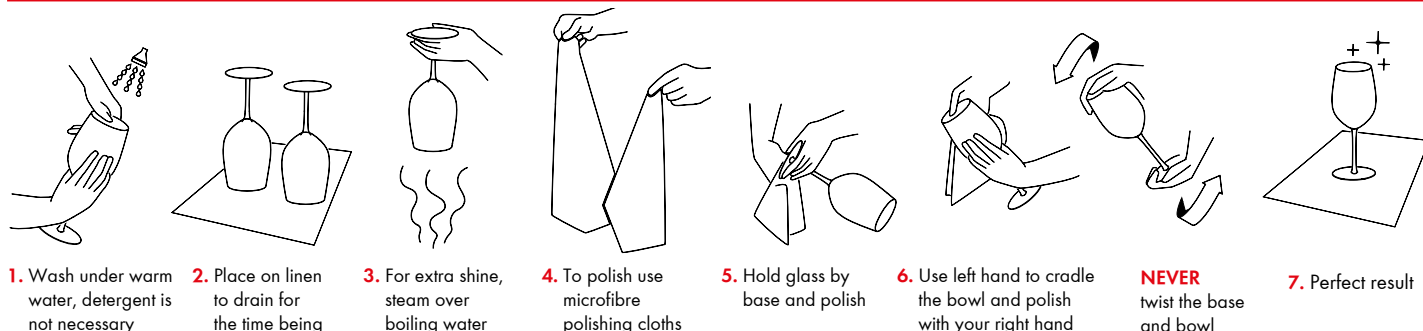

1. Wash under warm water, detergent is not necessary
2. Place on linen to drain for the time being
3. For extra shine, steam over boiling water
4. To polish use microfibre polishing cloths
5. Hold glass by base and polish
6. Use left hand to cradle the bowl and polish with your right hand
- NEVER** twist the base and bowl
7. Perfect result

CAUTION: A Riedel glass is a grape varietal specific wine tool! This shape works best with wines made from specific grapes. Please read the instructions below to guarantee maximum enjoyment. Riedel has researched the

grape varietal sensation, leading to the conclusion, on which the world's wine experts agree; that the enjoyment of aroma, taste, texture and finish of a wine, is maximized by using the right "WINE TOOL"



Rules when handling connoisseur glasses



1 Filling the glass

Do not over-pour. This will ensure maximum development of the wine's bouquet, and also provide the most elegant table setting.



2 Holding the glass

The appropriately filled glass should always be held by the stem rather than the bowl.



3 Swirling the glass

Carefully swirling the glass allows oxygen into the wine by increasing its surface area and helps release the wine's rich, mature aroma.



4 Why and how to decant wines

To decant wine means to transfer it from its bottle to a decanter or carafe before drinking. During storage or aging, wine can develop a solid deposit or sediment at the bottom of the bottle. Decanting is an easy means of separating the sediment from the wine. It also helps the wine breathe, as the greater surface diameter lets more oxygen reach the wine than the bottle does.



5 Wine temperature

Before decanting/or serving wine, store it at appropriate temperatures (red wine 59-63°F, 15-17°C, white wines at 50-54°F, 10-12°C). The proper serving temperature enhances the quality of the wine by allowing it to fully develop its characteristic aromas and flavours.

RIEDEL

„sensory“
work shop



FINE RIM

laser cut, polished rim essential to direct the flow of wine

FINE CRYSTAL

break resistant fine crystal ensures perfect clarity, essential to see the exact colour

GRAPE VARIETAL SPECIFIC BOWL

bowl shape enables the wine to develop its tastes and aromas. Stemware features finely-tuned glass consisting of 3 variables: shape, size and rim diameter

SENSORY WORKSHOP

Riedel glasses are developed in sensory workshops

SEAMLESS STEM

smooth, seamless

LOGO

This *Riedel* signature trademark helps our customers to distinguish immediately between handmade products and those made by machine. Our machine-made products carry this **RIEDEL** trademark.

BASE

Greater stability and breakage resistant

1. ADDITIONAL COSTS FOR CUSTOMERS CALIBRATION AND POUR AID

- No stock production. Manufacturing after fix order.
- Minimum order quantity 120 pieces per glass size (for re-orders as well).
- A quantity +/- 10% compared to the order quantity has to be accepted by the client.

The following prices are given for special calibrations and pour aid as per the German Calibration Act, if they are not included in the collection according to the price list:

prices per piece and per glass size orders exceeding: (Single marks / Double marks)	120 pcs.	600 pcs.	2500 pcs.
machine blown glass	€ 0,75	€ 0,70	€ 0,45

2. SIGNETS & VIGNETTES - SILK SCREEN PRINTING (WITHOUT CALIBRATION AND POUR AID)

- On bowl only.
- No stock production. Manufacturing after fix order.
- Minimum order quantity 60 pieces per glass size (for re-orders as well).
- A quantity +/- 10% compared to the order quantity has to be accepted by the client.

For the first production you have to pay non-recurring tool costs of Euro 175 if you have a appropriate artwork. If we have to re-produce the artwork we have to charge approx Euro 300 May we ask you to send us your artwork in order or us to determine the appropriate technique to execute your vignette. Silk screen printing costs for Gold and Platinum upon request.

pieces	prices per piece and per glass size orders exceeding: for stem glasses machine-made; color: matt white
60 pcs.	€ 3,85
120 pcs.	€ 2,75
240 pcs.	€ 1,65
300 pcs.	€ 1,30
420 pcs.	€ 1,10
540 pcs.	€ 0,75
1.200 pcs.	€ 0,55
2.500 pcs.	€ 0,45
5.000 pcs.	€ 0,42
10.000 pcs.	€ 0,40

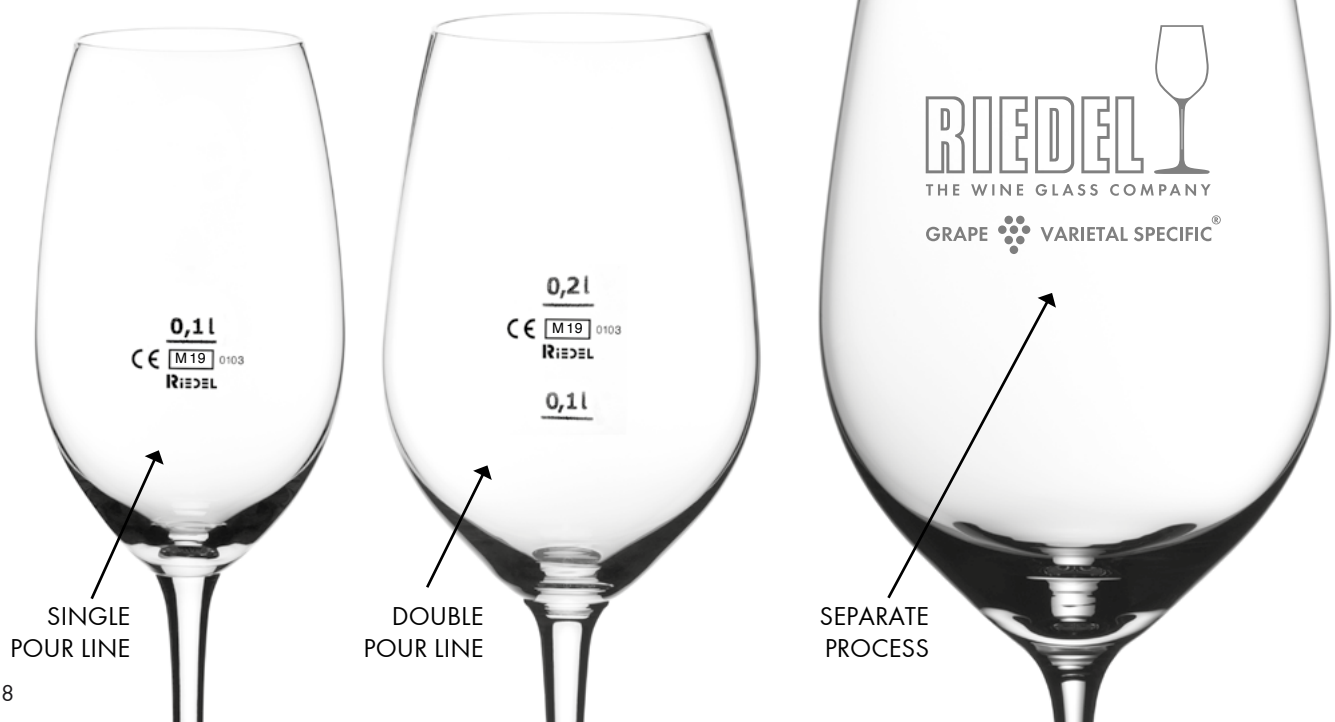

SINGLE POUR LINE

DOUBLE POUR LINE

SEPARATE PROCESS

3. SIGNETS & VIGNETTES - SILK SCREEN PRINTING (INCLUDING CALIBRATION AND POUR AID)

- No stock production. Manufacturing after fix order.
- Minimum order quantity 120 pieces per glass size (for re-orders as well).
- A quantity +/- 10% compared to the order quantity has to be accepted by the client.

prices per piece and per glass size orders exceeding:	120 pcs.	240 pcs.	600 pcs.	2500 pcs.
For stem glasses, machine made Color: matt white	€ 2,40	€ 1,40	€ 0,99	on request

For the first production you have to pay a one time tool costs of Euro 175 you have the appropriate artwork. If we have to re-produce the artwork we have to charge approx Euro 300. May we ask you to send us your artwork in order to determine the appropriate technique to execute your vignette. Silk screen printing costs for Gold and Platinum upon request.

4. INFORMATION ABOUT SILK SCREEN DECORATION:

In decorating glass with the screen printing process, colour is pressed through a silk screen to the glass surface and fixed to the glass during a temperature treatment. The colours, used by RIEDEL, are organic colours without heavy metals (such as lead, barium, etc.) or other toxic components. These colours have a high dishwasher resistance, but compared with ceramic colours a lower mechanical resistance.

5. ATTENTION:

The water hardness for cleaning glass, should not be less than 3° d.H.

Glasses with organic colours should be placed in the dishwasher in a way that they cannot make contact with each other during the washing process. If cleaning the glasses by hand, please do not use a scouring brush or abrasive detergents.

Be aware that fully desalinated water is extremely aggressive to both the glass surface and screen print decoration.

Over/underproduction (+10/-10 %) may be possible and will be billed accordingly.



SEPARATE
PROCESS



GO GREEN - SUSTAINABILITY



Our Glassware

- Durable / sustainable product - long lasting and reusable for many years
- Up to 50% made from recycled Riedel crystal within our factories
- Crystal-Glass is inert and does not react with substances or materials that it comes into contact with (in contrast to plastic which, for example, can release Bisphenol A (BPA))
- Production processes are completely BPA-free / no plastic
- Our crystal glass is compliant with all known migration limits and is fully certified for safe usage with food and drinks
- 100% recyclable



Our Packaging

- Green Dot certified (production sites Germany - the company is committed to recovery and recycling)
- 45% FSC® - Forest Stewardship Council
- Reclay whole system (production sites Austria)
- Recyclable
- We work with sustainability-committed suppliers only. For example, with Mondi RIEDEL has won a Sustainability Award for the jointly developed packaging solution from Riedel Performance.

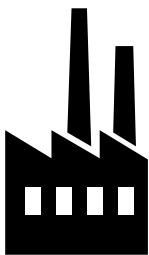

Our Factories

- Implemented environment certificates ISO 14001: 2015 and ISO 50001: 2011
- Main raw materials are locally sourced e.g. quartz sand from Hirschau (short transport routes)
- Energy-saving projects include: compressed air, burner technology, energy efficient drives, LED lighting, waste heat recovery, water saving measures
- Substitution of hazardous substances with more environmentally friendly options

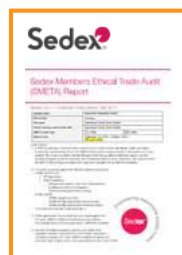

www.riedel.com

GENERAL TERMS AND CONDITIONS OF CONTRACT OF TIROLER GLASHÜTTE GMBH 2023 ("TG").

1. Scope of Application.

All provisions of goods and services by Tiroler Glashütte GmbH ("TG") to or for the benefit of each customer of TG (the "Customer") shall be subject to the following General Terms and Conditions of Contract (the "T&C"), unless otherwise expressly agreed upon in writing and signed by TG. By placing an order with TG for the supply of products sold by TG (the "Products") and/or for services provided by TG or otherwise accepting the supply of Products and/or services by TG (or any part thereof), Customer (a) agrees to purchase the Products and services on and subject to the T&C and (b) acknowledges and agrees that, in respect of any other terms and conditions (including terms and conditions accompanying any purchase order or received from Customer): (I) those terms and conditions are not effective and TG will not be bound by them; (II) the T&C supersedes and replace any such terms and conditions in their entirety; unless such terms and conditions are duly acknowledged and expressly agreed to in writing and signed by TG. For the avoidance of doubt, the acceptance of orders or performance of services by TG shall not be regarded as the grant of any entitlement to future fulfillment of orders or provision of services by TG, and nothing in the T&C shall be construed as creating a relationship of exclusivity between Customer and TG.

2. Orders.

2.1. All orders by Customer (the "Orders", or each an "Order") shall become legally effective and binding on Customer upon TG's delivery of its written acceptance of each such Order (an "Order Confirmation") or, in the absence of such Order Confirmation, by delivery of the Products comprising such Order to Customer. Customer may modify any Order at any time before TG's delivery to Customer of the Order Confirmation for such Order (or in the absence of such Order Confirmation, delivery of the Products comprising such Order), but under no circumstances shall Customer be permitted to modify any Order more than five (5) calendar days after placing such Order. TG will communicate expected lead-times of Products in the respective Order Confirmation (in this context also see **Clause 6.4.**)

2.2. Once an Order is confirmed by TG or delivered to Customer, such Order may not be cancelled by Customer except with the prior consent in writing of TG, in which case Customer will be liable to TG for all costs, expenses and other losses incurred by TG in connection with such cancellation.

2.3. TG reserves the right, in its sole discretion, to (I) reject any Order at any time without giving any reasons before sending the Order Confirmation (or, in the absence of an Order Confirmation, before delivery); (II) cancel any Back Orders (see **Clause 2.9**) at any time by giving Customer notice of such cancellation; (III) accept Orders only with respect to amounts that from experience correspond with usual quantities ordered by enterprises of comparable size; and/or to (IV) terminate any framework agreement possibly existing at any time with immediate effect without giving any reasons.

2.4. Customer shall comply on all its Orders with all guidelines communicated by TG regarding minimum Order values and minimum Product Orders, including those set out in the T&C.

2.5. Special Orders: Orders for any Products not featured in the applicable Price Books ("**Special Orders**") require a 50% deposit. Special Orders can be combined with any other Orders to meet Order minimums. Quantities of Special Orders can only be ordered in full master packs. No returns or cancellations on Special Orders are permitted.

2.6. Value Packs: Any preferential conditions on which Customers may purchase packs containing free Products ("**Value Packs**") must - to the extent legally permissible - be passed on to the end-consumer in at least the same amount. Customer may not un- or repack Value Packs and may not sell any merchandise included in Value Packs individually.

2.7. Limited Editions: TG reserves the right to offer Products marked as "Limited Edition" in a certain amount and for a certain time period and under certain allocation criteria to Customer.

2.8. Glassware marked as "**On-Premise Glass Collection/Glassware**" is reserved for the hospitality industry ("**On-Premise Customers**") only, and is not intended for resale, the retail trade and/or for end-consumers.

2.9. Back Orders: If an ordered Product is out of stock, TG will notify Customer and will automatically place the Product on back order, and send the stock as soon as it becomes available ("**Back Order**"). If Customer does not want the Product comprising such Back Order, Customer needs to advise TG immediately after receipt of such Back Order notification accordingly in writing, otherwise Back Orders cannot be cancelled by Customer.

2.10. Customer acknowledges that the packaging and labeling of the Products as designed and implemented by TG is critical to maintain the recognition and the image of the respective Brands (as defined in **Clause 3.2.**). Without the prior written consent of TG, Customer shall not modify or remove or otherwise make illegible or unreadable any packaging, labeling, tags, markings or other items, such as QR Codes, promotional materials or instructions, howsoever affixed to the Products themselves or to their packaging or accompanying the Products.

2.11. The Products shall not be unpacked from their original packaging as shipped to Customer or be repacked by Customer, but shall be sold by Customer in its original packaging, unless explicitly priorly authorized by TG in writing.

2.12. In the event that TG explicitly authorizes Customer in writing to unpackage

(unwrap) and/or repackage Products (collectively, "**Authorized Packaging Changes**"), Customer shall ensure that the unpackaged and/or repackaged Products and the packaging used by the Customer (the "**Customer Packaging**") comply with all applicable laws, rules, and regulations, including but not limited to those laws, rules, and regulations that concern such Products' and Customer Packaging's labelling, marking, tagging, waste management, boxing, marketing, storage, distribution, handling, cleaning and sale, and Customer shall indemnify, defend, and hold harmless TG and its affiliates for any violations or alleged violations thereof. TG and its affiliates shall not be responsible for and Customer shall indemnify, defend and hold TG and its affiliates harmless from, and against, any and all claims, suits, losses, damages, demands, injuries, costs and expenses (including reasonable attorney's fees and costs) arising out of or related to Authorized Packaging Changes, including but not limited to any damage or loss arising out of the labelling, marking, tagging, waste management, boxing, marketing, storage, distribution, handling, cleaning and/or sale of the Products or of the Customer Packaging.

2.13. In the event that Customer elects to purchase TG's Product comprising two wine glasses within packaging permitting Customer's inclusion of one bottle of wine (the "**2 Glasses 1 Bottle Product**"), Customer shall ensure that the 2 Glasses 1 Bottle Product complies with all applicable laws, rules, and regulations, including but not limited to those laws, rules, and regulations that concern such 2 Glasses 1 Bottle Product's labelling, marking, tagging, waste management, packaging, marketing, storage, distribution, handling, cleaning and sale, and Customer shall indemnify, defend, and hold harmless TG and its affiliates for any violations or alleged violations thereof. TG and its affiliates shall not be responsible for and Customer shall indemnify, defend and hold TG and its affiliates harmless from, and against, any and all claims, suits, losses, damages, demands, injuries, costs and expenses (including reasonable attorney's fees and costs) arising out of or related to 2 Glasses 1 Bottle Products, including but not limited to any damage or loss arising out of the labelling, marking, tagging, waste management, boxing, marketing, storage, distribution, handling, cleaning and/or sale of the 2 Glasses 1 Bottle Product.

2.14. Customer understands that TG's ability to effect proper quality control measures, including but not limited to quality control oversight over the Brands, Trademarks and the Products, requires TG's unfettered ability to track its inventory at all stages of the Products' supply chain. Accordingly, Customer acknowledges and agrees that it will not under any circumstances remove, deface, obscure, cover up, or otherwise make illegible or unreadable any unique identifying label, mark, tag, scan code, or identification number (including but not limited to bar codes, RFIDs, and QR codes) that is howsoever affixed to any Product or the packaging of any Product.

2.15. In the event that Customer, as determined by TG in its sole discretion, is found to have violated any part of **Clause 2.10, 2.11, 2.12, 2.13 or 2.14**, Customer's status as an authorized purchaser and as the case may be, as well reseller of the Products shall be subject to immediate termination, and TG shall reserve all rights and remedies it may have against Customer pursuant to these T&C, any other agreement entered into or otherwise governing the relationship between TG and Customer, and applicable law.

2.16. TG does not provide Customers with any kind of marketing support, unless decided by TG in its sole discretion on an individual basis case by case. The granting of any kind of marketing support by TG to a Customer does not create any further claims by Customer for continued support. Customer will not be reimbursed for any kind of investments or promotional events or for any kind of promotional material regarding the Brands (see **Clause 3.2.**), irrespectively if Customer purchased such material from TG or from a third party.

3. Customer Obligations.

Customer hereby agrees at all times to observe and abide by the obligations (the "**Customer Obligations**") as outlined in this **Clause 3.** of the T&C.

3.1. Retail-Customers: Retail-Customers may sell retail Products received from TG to end-user consumers. Active sales to certain groups of resellers or to any kind of resellers in certain territories, which TG has exclusively reserved for itself or for third party dealers, are prohibited. TG will inform Customer respectively. Passive sales are exempted from the above restriction. Provisions in the selective distribution network remain unaffected by this **Clause 3.1.**

3.2. Customer acknowledges its obligation to maintain and promote the extremely high standard of the Products reputation as comprising some of the world's finest glassware, the goodwill symbolized by the "Riedel", "Spiegelau" and "Nachtmann" brands (the "**Brands**"), and the associated trademarks (the "**Trademarks**") and trade dress and Products, and to further refrain from any conduct that could be viewed as disparaging or otherwise having a negative impact on the image of the Products, the Brands, the Trademarks, TG and its affiliates, and shall include, but shall not be limited to, the selling of the Products to or via mass merchandisers or discount stores that were not specifically authorized by TG in writing, and the selling of the Products next to other goods that are infringing upon the intellectual property rights of TG or of its licensors.

3.3. Customer will conduct its activities strictly in accordance with the T&C and all applicable laws and regulations. In the event that Customer is found to have violated any part of **Clause 3.**, Customer's status as an authorized purchaser and as the case may be, as well reseller of the Products shall be subject to immediate termination, and

GENERAL TERMS AND CONDITIONS OF CONTRACT OF TIROLER GLASHÜTTE GMBH 2023 ("TG").

TG shall reserve all rights and remedies it may have against Customer pursuant to these T&C, any other agreement entered into or otherwise governing the relationship between TG and Customer, and applicable law.

4. Prices.

The prices for the Products and/or services are as set out in the applicable printed and/or digital Price Books provided to Customer by TG from time to time (the "Price Books"). TG reserves the right to change the Product assortment and/or the service assortment as well as the prices for its Products and/or services from time to time, and the prices applicable at the time an Order is placed are those that apply to the Products and services purchased. Unless otherwise stated in TG's applicable Payment & Delivery Terms (as defined in **Clause 5.1**) all prices are stated net per sales unit, EX WORKS („EXW", INCOTERMS 2020) TG warehouse, Germany, excluding the packaging for shipment. TG issues its invoices in Euros or – at TG's sole discretion – in another currency depending on the Customer address. Prices are exclusive of statutory VAT or other taxes, fees or duties. If VAT is payable, it will be stated separately in TG's invoice.

5. Terms of Payment.

5.1. The payment and delivery terms applicable to Customer are set forth separately in TG's "Payment & Delivery Term Sheets" (the "Payment & Delivery Terms"), which are hereby expressly incorporated into and form an integral part of these T&C. TG reserves the right (I) to change its Payment & Delivery Terms from time to time, with any such changes applying to future Orders placed, or (II) to suspend fulfillment of any agreement with Customer, if TG has reason to believe that such change/suspension is necessary due to Customer's financial situation or payment history.

5.2. TG may ask for a payment confirmation to be issued by a bank accepted by TG. Payment will be deemed effected as soon as TG is able to freely dispose of the same at its registered office. If payments are effected in freely convertible currencies other than the invoicing currency, Customer will bear the exchange rate risk. Any bank charges are at Customer's expense. Customer acknowledges its obligation to pay default interest of 11% p.a. as of the due date. Any claims, counterclaims or claims for compensation of Customer shall not entitle Customer to any extension of the period stipulated for payment.

5.3. An eventually granted cash discount may only be deducted, if all outstanding invoices have been fully paid by Customer.

5.4. TG is not obliged to accept checks or bills of exchange; they will only be credited as payment subject to them actually being honored to the value to which they are at disposal. All costs incurred in connection with acceptance of bills of exchange or checks, in particular discounting charges and interest, shall be borne by Customer.

5.5. Each delivery by instalment shall be deemed an independent transaction for billing and payment purposes.

5.6. In the event of default in payment under these T&C by more than sixty (60) days past due, TG may suspend all deliveries until the full outstanding amount has been credited to TG's account. Although TG may accept new Orders, these will not be processed and/or delivered.

5.7. If (a) Customer defaults in payment under these T&Cs by more than sixty (60) days past due OR (b) all or substantially all of the assets of Customer are sold or otherwise transferred; OR (c) there is a change in control with respect to Customer; OR (d) the legal form of Customer is changed; OR (e) in the reasonable opinion of TG, Customer's financial situation changes or deteriorates materially (e.g. a bill of exchange or cheque provided by Customer is not honored); OR (f) at any time TG considers (acting reasonably) that Customer is a credit risk, THEN: (g) all outstanding accounts receivable, also under bills of exchange, will become due for payment immediately irrespective of their due date and (h) TG shall be entitled to terminate or cancel all current contracts and/or confirmed Orders, request damages in lieu of performance, stop any or all deliveries, require proper security before making any delivery or effect delivery only against full cash amount payable on delivery (if Customer has already advanced any payments in relation to terminated or cancelled Orders, TG will refund those amounts or allocate/offset them accordingly); and (i) TG will retain title to Products that have not been paid for as described under **Clause 12**. and TG may ascertain and collect any such Products that are in the possession, custody or control of Customer.

6. Delivery and Passing of Risk.

6.1. Unless otherwise stated in TG's applicable Payment & Delivery Terms or agreed in writing by TG, all deliveries will be effected EX WORKS („EXW", INCOTERMS 2020) TG warehouse, per address RSN Logistik GmbH, Weiden i.d. Of., Germany.

6.2. Unless otherwise stated in TG's applicable Payment & Delivery Terms, if so requested by Customer and agreed in writing by TG, Products can be shipped to a different destination. Save where otherwise agreed, TG is entitled to determine the kind of shipment (in particular the forwarding agency, shipment route, packaging). Products will be shipped at Customer's sole cost and risk.

6.3. If Products are shipped to a different destination upon Customer's request, the risk shall pass to Customer on the Products' surrender to the person designated to carry out shipment. Customer shall assume all risk to Products during transportation thereof, TG shall not be obligated to replace or credit Customer for Products that are stolen, lost,

broken, damaged, or otherwise altered during or as a result of their transportation, and Customer shall be solely responsible for filing any and all claims for loss or damage with the responsible entity or entities.

6.4. Deliveries will be made by TG according to its operational capabilities. Communicated lead-times refer to TG ex-warehouse dates and are estimates only and are not binding; lead-times for Special Orders and Limited Editions will be communicated to Customer on a case-by-case basis, also refer to TG ex-warehouse dates and are estimates only and are not binding. To the extent permitted by law, TG will not be liable for its failure to make any delivery by the estimate date and any claims for damages due to non-performance or delayed performance are excluded, and Customer waives any and all claims against TG and its affiliates for damages and other liabilities arising from or due to TG's actual or alleged non-performance or delayed performance.

6.5. TG will observe commercially reasonable efforts in its observance of these T&C, which observance shall be subject to unforeseeable events or events not otherwise contemplated by these T&C. TG will not be responsible for any delay or failure to perform its obligations under these T&C or otherwise, which arises out of or is due to unforeseeable events or events independent of the intention of the parties, such as events of force majeure ("Force Majeure Event"), including, by way of example and not of limitation, all events of pandemics, epidemics, war, terrorist actions, interventions, instructions and prohibitions of official authorities, delays in transport and customs clearance, transport damage, inclement weather, lack of energy, financial crisis, labor conflicts as well as delays in delivery on the part of suppliers for any reasons. Delivery times will be prolonged where any Force Majeure Event occurs. If Products, which are ready for shipment, cannot be shipped through no fault of TG or if Customer does not want Products to be shipped, TG may store Products at Customer's cost and risk, whereby delivery shall be deemed fulfilled. The agreed payment terms are not changed thereby.

6.6. Retail-Products are shipped in brown master packs (order units). The master pack is only to protect the retail-Products and is not designed to be used as shippable outer carton and may not be used as such. Any other use of the master pack, in particular its use for shipping, is the sole responsibility and risk of Customer.

6.7. The cost of any special packing and packing materials used in relation to the Products are at Customer's sole expense notwithstanding that such cost may have been omitted from any Price Book or quotation. Customized packaging is subject to the signing of a separate packaging agreement.

6.8. Regarding Special Orders, TG reserves the right to supply the quantity deviations of +/- 5% of the quantity ordered (the "Permitted Deviation"), which is customary within the industry. Provided that TG's fulfillment of any Special Order is within the Permitted Deviation, the quantity actually delivered shall be paid for by Customer in full.

6.9. If Products are to be delivered at the TG warehouse, TG will advise Customer about twenty (20) business days in advance of the respective delivery date. Partial deliveries of an Order (i.e. deliveries by instalments) are permitted. Customer shall pick-up all available and prepared Products, including partial deliveries of an Order, within ten (10) business days as of the communicated delivery date. If Customer informs TG that Customer will not collect the respective delivery or if Customer fails to pick such delivery within this ten (10) business days window, TG shall be entitled to either (I) partially or in total cancel the respective Order or (II) to store the Products at Customer's cost (at EUR 20 net per pallet per week) and risk, whereby delivery to Customer shall be deemed fulfilled and will be invoiced.

7. Partial Delivery.

Deliveries by instalments (i.e. partial deliveries) shall be permitted and may be invoiced. If TG delivers any of the Products by instalments, and any one of those instalments is defective/non-compliant for any reason (as defined in **Clause 8.**), it is not a repudiation of the contract of sale formed by the T&C.

8. Notice of Defects/Non-Compliance, Warranty.

8.1. Any defect claims or non-compliances with the contract must be made in writing within **twenty-eight (28) days** from the date of delivery of the Products and in any event prior to their use or re-sale, including a detailed description and photos of the defect or the non-compliance; otherwise the Products are deemed accepted by Customer.

8.2. Customer shall assume all risk to Products during transportation thereof. TG shall not be obligated to replace or credit Customer for Products that are stolen, lost, broken, damaged, or otherwise altered during or as a result of their transportation, and Customer shall be solely responsible for filing any and all claims for loss or damage with the responsible entity or entities.

8.3. Any defects or non-compliances caused as result of a Force Majeure Event shall be excluded from TG's warranty.

8.4. For glass clouding a warranty of 2 (two) years as of the respective production date (bottom stamp) is granted. No warranty is provided for mechanical damages to the surface.

8.5. Customer acknowledges that deviations may occur between Products from the same series for technical reasons and because of the materials used in the course of the production of glass products, in particular with respect to size, weight, ovality, or the

GENERAL TERMS AND CONDITIONS OF CONTRACT OF TIROLER GLASHÜTTE GMBH 2023 ("TG").

vertical axis according to the relevant technical drawings, which cannot be influenced by TG. Handmade Products or handmade Product parts may be subject to sample and size deviations. Therefore, all such deviations between Products, in particular compared to earlier deliveries of the same Product, do not constitute a defect.

8.6. In case of a valid claim in respect of any defective/non-compliant Product, TG will, at its sole discretion, either arrange delivery of a replacement Product (subject to its operational capabilities) or issue a credit note for the price paid by Customer to TG for the respective defective/non-compliant Product, but not both. If TG chooses to arrange delivery of a replacement Product, Customer is required to return the defective/non-compliant Product at Customer's cost and risk to the warehouse determined by TG. Any and all other warranty claims of Customer shall to the extent permitted by law be excluded. TG will not replace any Products broken or damaged if master packs are used for shipping (see **Clause 6.6.**). Further, damaged packaging is not replaceable.

8.7. The rights relating to defects and non-compliance do not apply in case a defect/non-compliance arises because Customer fails to observe TG's or a manufacturer's Product or Product packaging instructions, recommendations or guidelines, in particular instructions, recommendations and guidelines for processing, handling, use, caring or cleaning of the Product, or by failing to observe generally accepted Product use practices.

9. Limitations of Liability.

9.1. Where liability for damages is subject to fault, TG's liability for damages – irrespective of the legal grounds – shall in each case be limited in accordance with this **Clause 9.**

9.2. TG shall not be liable if and to the extent that Product instructions, recommendations and/or guidelines, in particular instructions for processing, handling, use, caring or cleaning of the Products and/or the Product packaging, and/or generally accepted Product use practices are not observed by Customer or its customer or other persons, unless Customer furnishes proof that the damage would have occurred even if the Product or Product packaging instructions, recommendations and/or guidelines had been observed. Further, TG shall not be liable for any damage or loss resulting from the purchase, handling, storage, packing, labelling, distribution, promotion, use, cleaning or sale of the Products by Customer.

9.3. TG shall only be liable for damage to the extent that the damage was caused by TG by gross negligence or willful intent. Liability for slight negligence is excluded, except in the case of personal injury. In such cases, however, TG's liability shall be limited to the foreseeable and typical damage.

9.4. The burden of proof lies with Customer.

9.5. In all other respects, TG's liability is excluded and Customer shall not be entitled to, and releases TG from, any additional claims, in particular for compensation of indirect damage or loss, or consequential damage, or loss of profits, goodwill revenue, savings or opportunity, whether in contract, tort (including negligence) or otherwise. For clarification, the cost of making a claim under this warranty will be borne by Customer.

9.6. Decorations of any kind not been made or commissioned by TG, such as engravings, silk-screenings etc., are the sole responsibility and risk of Customer. TG will not be responsible and shall be excluded from any warranty whatsoever, especially but not limited to that heavy metals or other dangerous materials are applied, or if the material used is not water-resistant or dishwasher-proof. Customer shall indemnify and hold TG and its affiliates harmless from any and all claims, suits, losses, damages, demands, injuries and expenses (including reasonable attorney's fees) arising out of or related to any claims made against TG based on any decorations (such as engraving, silk-screening, etc.) made to the Products by Customer.

9.7. Except as provided in the T&C, TG makes no warranties or representations as to the Products or services to Customer or to any other person. All implied warranties, including but not limited to implied warranties of merchantability and fitness for a particular purpose are hereby expressly excluded to the extent permitted by law.

10. Returns.

Unless due to their defectiveness or non-compliance Products are returned in accordance with **Clause 8.**, all returns are subject to TG's prior written approval and subject to the exclusions as set out in these T&C. Special Orders, Limited Editions, Products that were un-packed from the original boxes, 2 Glasses 1 Bottle Products, Products that have Authorized Packaging Changes or are engraved, decorated or are personalized in any other way cannot be returned and will not be reimbursed. Returned Products must be part of the current Price Books and in mint, resalable condition, packed in the original undamaged boxes and in the original sealed master packs. Returns must be shipped within thirty (30) days after having received TG's written prior approval and shall be delivered to the warehouse defined by TG, freight, risk and costs at Customer's expense and responsibility. For Products returned in accordance with these provisions and such Products not being defective/non-compliant under **Clause 8.**, the EXW TG warehouse, Germany, Product net price paid by the Customer for the respective purchase will be credited minus a 1.5% restocking and handling fee. Any returns not in conformity with the foregoing may be refused by TG and will be not reimbursed.

11. Intellectual Property Rights.

11.1. TG or TG's licensors hold any and all rights, titles, good-will, and interest of any nature whatsoever, including but not limited to any and all intellectual property rights,

in particular copyrights, trademarks, trade secrets, design patent, patent rights and/or design rights, relating to the Products, the Product designs, the glassware samples and the glassware sample designs and prototypes, including, but not limited to, the respective drawings, tools, shapes and molds.

11.2. Any and all tools, molds, drawings, plans and prototypes provided to a Customer are the sole property of TG, including but not limited to any and all intellectual property, even if Customer bears the costs of their acquisition in part or in full, and will not be handed over at the end of any kind of cooperation or contract.

11.3. Customer is entitled to the restricted use of the Brands and/or Trademarks affixed to the Products or their packaging in its unchanged and originally packed form, in order to identify the Products. By doing so, Customer does not acquire any rights or licenses to the Brands or the Trademarks, or any other proprietary material of TG or its licensors. Customer undertakes to refrain from any other use.

11.4. Any use of the Brands, the Trademarks or of any other intellectual property of TG or of TG's licensors, as well as photos or videos thereof, in publications, electronic (internet) advertising, social media pages, or printed matter is only permitted upon prior written authorization of TG. In addition, Customer undertakes not to use any marks or signs that are likely to be confused with those of TG or of TG's licensors, or with "Riedel", "Spiegelau" or "Nachtmann" or similar marks or signs or to have them protected in whatever form, in any jurisdiction.

11.5. Any and all materials and related documentation TG provides to Customer hereunder or through any contract together with any and all rights, titles and interests in the intellectual property, including but not limited to the Brands, the Trademarks, or any other proprietary material of TG and its licensors as well as all goodwill and copyright, in and arising from the Brands and the Products, vested therein or related thereto, remain the sole and exclusive property of TG or its licensors. Documents such as catalogues, brochures, illustrations, photos, videos, and the like as well as samples and designs remain at all times the intellectual property of TG or TG's licensors, protected by the relevant statutory provisions regarding reproduction, imitation, competition, etc. Customer undertakes not to make such material and documents available to third parties, either in whole or in part, without TG's prior written authorization or to use them for any purpose apart from the purpose for which they were handed over to Customer.

In case an authorization is granted that allows Customer to make such material and documents available to third parties, Customer shall be obliged to impose all obligations arising out of these T&Cs upon such third party. Customer remains liable to TG for any acts or omissions of such third party, and Customer shall hold TG and its affiliates harmless from any and all claims and expenses (including reasonable attorney's fees) arising out of or related to any such acts or omissions. If no Order is placed, Customer must return all material and documents.

11.6. Any use of the Brands or of any intellectual property rights of TG or of TG's licensors on social media platforms such as Facebook, Twitter, Instagram, TikTok etc. or any setting up of a "Riedel", "Spiegelau" or "Nachtmann" account on such social media platforms shall only be permitted upon prior written consent of TG.

12. Retention of Title.

12.1. TG shall retain title to the Products and samples delivered until full payment is received for such Products and/or samples by TG.

12.2. However, Customer is entitled to resell the Products in ordinary business in the usual way customary in the trade. If Products, which have not been paid for yet are sold, Customer shall assign the claim thus arising vis-à-vis third parties to TG. TG shall be entitled to disclose the assignment. Customer shall immediately make available to TG all information required in order to pursue all claims and agrees to comply with all formalities that may be necessary for a valid assignment.

12.3. Customer is not entitled to pledge or hand over Products of TG that have not been paid for as security. Customer is obliged to claim the title of TG to the Products in relation to third parties and to notify TG immediately in writing if third parties assert claims with respect to the Products or if execution is initiated.

13. Severability.

If any provision of the T&C is deemed ineffective or adjudicated to be invalid by a competent authority, the validity of the remaining provisions shall not be affected. The Parties shall agree on a new effective provision which comes as close as possible to the commercial purpose of the ineffective provision without delay.

14. Applicable Law, Place of jurisdiction.

14.1. The T&C and the contract concluded with Customer including the pre- and post-contractual phases and effects shall be governed by and shall be interpreted in accordance with **Austrian law**, excluding its conflict of law rules and the provisions of the UN Sales Law (CISG – United Nations Convention on Contracts for the International Sale of Goods).

14.2. The exclusive jurisdiction of Kufstein District Court, Austria, or Innsbruck High Court, Austria, (depending on jurisdiction over subject) is agreed for any and all disputes arising from or in relation to the contract concluded with Customer or the T&C underlying the contract, including the pre- and post-contractual phases and effects. However, TG is free to sue at Customer's registered office.

**AUSTRIA****Tiroler Glashütte GmbH**

Weissachstraße 28-34
6330 Kufstein, Austria
Phone: +43 (0) 5372 64896
Fax: +43 (0) 5372 63225
Email: info@riedel.com

**JAPAN****RSN Japan Co. Ltd**

Aoyama Twin Tower (West) 2 F
1-1-1 Minami-Aoyama
Minato-Ku, Tokyo 107-0062, Japan
Phone: +81 3 4530 6900
Fax: +81 3 5775 5889
Email: info@riedel.co.jp
www.riedel.co.jp

**AUSTRALIA****RSN Australia Pty Ltd**

201/32 Walker Street
North Sydney NSW 2060, Australia
Phone: +61 2 9966 0033
Fax: +61 2 9906 7802
Email: info@rsnaustralia.com.au

**NEW ZEALAND****RSN New Zealand Pty Limited**

PO Box 99841
Newmarket 1149 Auckland, NZ
Phone: +612 99 66 00 33
Email: info@rsn.co.nz

**CANADA****Crystal of Canada, Inc.**

110 Fieldcrest Avenue
Raritan Plaza 1, 4th Floor
Edison, NJ 08837, USA
Phone: +1 888 4-RIEDEL
Fax: +1 732 346 8977
Email: info@riedelcanada.com

**SWITZERLAND****RSN-Schweiz GmbH**

c/o KD Zug Fiduciary Ltd.
Untermüli 7, Postfach 7444
6302 Zug, Switzerland
Phone: +41 41 766 26 35
Email: webshopsui@riedel.com

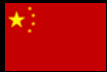
**CHINA****RSN Crystal Trading (Shanghai) Ltd.**

RM2301-2302 Citic Plaza
859 Sichuan Road North
Shanghai 200085, China
Phone: +86 21 60707358
Email: info.asia@riedel.com

**UNITED KINGDOM****RSN.UK Ltd t/a Riedel**

Lakeside House
3 Trentham Office Village
Trentham Lakes South
Stoke on Trent, ST4 8GH
United Kingdom
Phone: +44 (0) 1782 646 105
Email: info@riedel.co.uk

**FRANCE****RSN Crystal France**

22 rue du Sentier
75002 Paris
Phone: +33 1 42 89 86 08
Email: riedelfrance@riedel.com

**USA****Crystal of America, Inc.**

110 Fieldcrest Avenue
Raritan Plaza 1, 4th Floor
Edison, NJ 08837, USA
Phone: +1 732 346 8960
Fax: +1 732 346 8977
Email: info@riedelusa.com

**GERMANY****RSN Deutschland GmbH Vertrieb**

Zacharias-Frank-Straße 7
D-92660 Neustadt a.d. Waldnaab
Phone: +49 (0) 9602 30-0
Fax: +49 (0) 9602 30-1100
Email: info@riedel.com

RIEDEL.COM